



M 4835 / M 5946  
*M 4835 / M 5946*

**Pag. 01**



V 745  
*V 745*

**Pag. 14**



M 35  
*M 35*

**Pag. 02**



N 805 / N 806  
*N 805 / N 806*

**Pag. 15**



M 7152 / M 7255  
*M 7152 / M 7255*

**Pag. 03**



V 805  
*V 805*

**Pag. 16**



N 505 / N 506  
*N 505 / N506*

**Pag. 04**



N 88  
*N 88*

**Pag. 17**



LN 56  
*LN 56*

**Pag. 05**



V 88  
*V 88*

**Pag. 18**



LV 56  
*LV 56*

**Pag. 06**



ME IC01  
*ME IC01*

**Pag. 19**



LN 70  
*LN 70*

**Pag. 07**



Assemblaggio accessori  
*Accessories assembly*

**Pag. 20**



M / MV  
*M / MV*

**Pag. 08**



Caratteristiche accessori  
*Accessories features*

**Pag. 22**



N 745 / N 746  
*N 745 / N 746*

**Pag. 13**

# Motore M4835 IP54

## Motor M4835 IP54

Motori C.C. a norme CEI ed IEC - magnete permanente - 2 poli  
D.C. motors CEI and IEC standards - permanent magnet - 2 poles

Alimentazione da batteria - tensione nominale 12/24V  
Battery supply - rated voltage 12/24V

Fattore di forma 1 - senza ventilazione  
Form factor 1 - no ventilated

Isolamento classe F - protezione IP54  
Insulation F class - protection IP54

Fili uscenti  
Free wires

MOTORE / MOTOR	M4835 ( 12 V )		M4835 ( 24 V )	
Coppia nominale / Rated torque	0.16 Nm		0.16 Nm	
Potenza nominale / Rated power	25 W	35 W	50 W	65 W
Velocità nominale / Rated speed	1500 min <sup>-1</sup>	2000 min <sup>-1</sup>	3000 min <sup>-1</sup>	4000 min <sup>-1</sup>
Corrente nominale / Rated current	2.4 A	3.2 A	2.4 A	3.2 A
Tensione nominale / Rated voltage	12 V		24 V	
Velocità a vuoto / No load speed	1800 min <sup>-1</sup>	2400 min <sup>-1</sup>	3700 min <sup>-1</sup>	4800 min <sup>-1</sup>
Peso / Weight	0.9 Kg		0.9 Kg	
Tolleranza / Tolerance	±10%			

S2-S3 SERVIZIO INTERMITTENTE  
INTERMITTENT DUTY

25-65W

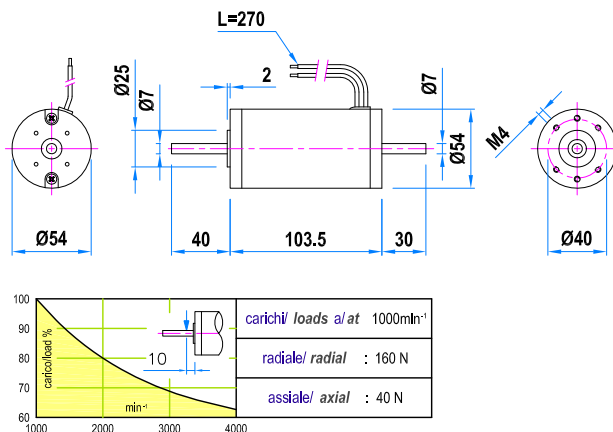
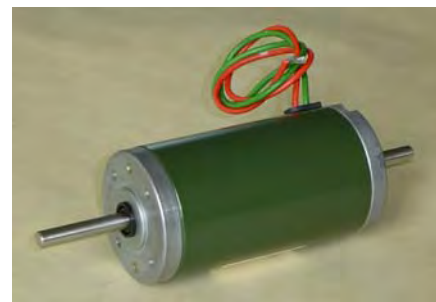

# Motore M5946 IP54

## Motor M5946 IP54

Motori C.C. a norme CEI ed IEC - magnete permanente - 2 poli  
D.C. motors CEI and IEC standards - permanent magnet - 2 poles

Alimentazione da batteria - tensione nominale 12/24V  
Battery supply - rated voltage 12/24V

Fattore di forma 1 - senza ventilazione  
Form factor 1 - no ventilated

Isolamento classe F - protezione IP54  
Insulation F class - protection IP54

Fili uscenti  
Free wires

MOTORE / MOTOR	M5946 ( 12 V )		M5946 ( 24 V )	
Coppia nominale / Rated torque	0.28 Nm		0.28 Nm	
Potenza nominale / Rated power	45 W	60 W	90 W	115 W
Velocità nominale / Rated speed	1500 min <sup>-1</sup>	2000 min <sup>-1</sup>	3000 min <sup>-1</sup>	4000 min <sup>-1</sup>
Corrente nominale / Rated current	4.2 A	5.6 A	4.2 A	5.6 A
Tensione nominale / Rated voltage	12 V		24 V	
Velocità a vuoto / No load speed	1700 min <sup>-1</sup>	2300 min <sup>-1</sup>	3400 min <sup>-1</sup>	4500 min <sup>-1</sup>
Peso / Weight	1.4 Kg		1.4 Kg	
Tolleranza / Tolerance	±10%			

S2-S3 SERVIZIO INTERMITTENTE  
INTERMITTENT DUTY

45-115W

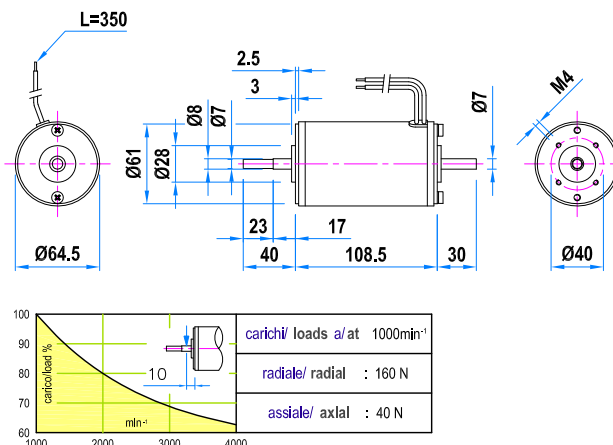

# Motore M35 IP54

## Motor M35 IP54

**S1** SERVIZIO CONTINUO  
CONTINUOUS DUTY

**20-100W**

Motori C.C. a norme CEI ed IEC - magnete permanente - 2 poli  
D.C. motors CEI and IEC standards - permanent magnet - 2 poles

Alimentazione da batteria - tensione nominale 12/24/48V  
Battery supply - rated voltage 12/24/48V

Fattore di forma 1 - senza ventilazione  
Form factor 1 - no ventilated

Protezione IP54 - isolamento classe F / H  
Protection IP54 - insulation F / H class

Terminali Faston  
Faston terminals



Tipo / Type	1500min <sup>-1</sup>			2000min <sup>-1</sup>			3000min <sup>-1</sup>		
M35.3	20 W	12 V - 2.4 A	0.13 Nm	27 W	12 V - 3.6 A	0.13 Nm	40 W	12 V - 4.8 A	0.13 Nm
		24 V - 1.2 A			24 V - 1.8 A			24 V - 2.4 A	
		48 V - 0.6 A			48 V - 0.9 A			48 V - 1.2 A	
M35.4	28 W	12 V - 3.3 A	0.18 Nm	37 W	12 V - 5 A	0.18 Nm	55 W	12 V - 6.6 A	0.18 Nm
		24 V - 1.7 A			24 V - 2.5 A			24 V - 3.3 A	
		48 V - 0.8 A			48 V - 1.2 A			48 V - 1.6 A	
M35.6	38 W	12 V - 4.5 A	0.24 Nm	50 W	12 V - 6.8 A	0.24 Nm	75 W	12 V - 9 A	0.24 Nm
		24 V - 2.2 A			24 V - 3.4 A			24 V - 4.5 A	
		48 V - 1.1 A			48 V - 1.7 A			48 V - 2.2 A	
M35.9	50 W	12 V - 6 A	0.32 Nm	67 W	12 V - 9 A	0.32 Nm	100 W	12 V - 12 A	0.32 Nm
		24 V - 3 A			24 V - 4.5 A			24 V - 6 A	
		48 V - 1.5 A			48 V - 2.2 A			48 V - 3 A	

Tolleranza / Tolerance ±10%

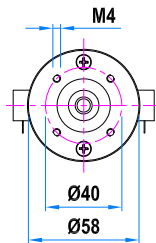
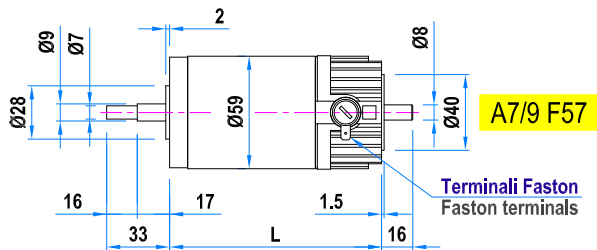

Tipo / Type	L	Peso / Weight
M35.3	99.5	0.9 Kg
M35.4	112	1.2 Kg
M35.6	132	1.4 Kg
M35.9	163	1.9 Kg

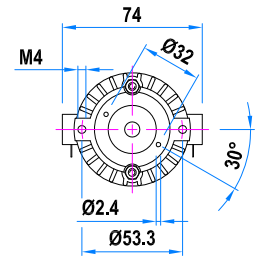

Predisposizioni posteriori  
Back shield pre arrangement

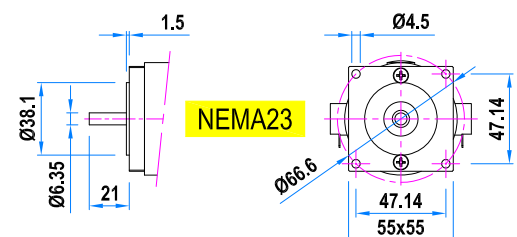
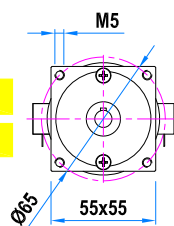
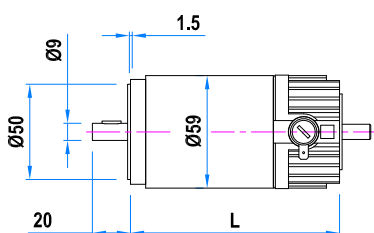
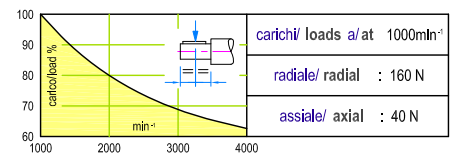
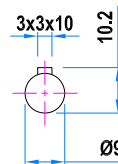
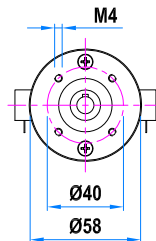
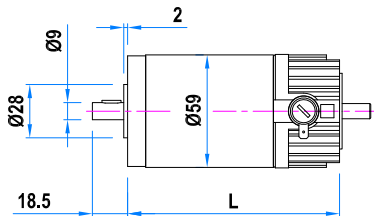

# Motore M7152 IP54

## Motor M7152 IP54

Motori C.C. a norme CEI ed IEC - magnete permanente - 2 poli  
D.C. motors CEI and IEC standards - permanent magnet - 2 poles

Alimentazione da batteria - tensione nominale 12/24V  
Battery supply - rated voltage 12/24V

Fattore di forma 1 - senza ventilazione  
Form factor 1 - no ventilated

Isolamento classe F - protezione IP54  
Insulation F class - protection IP54

Fili uscenti  
Free wires

S2-S3 SERVIZIO INTERMITTENTE  
INTERMITTENT DUTY

80-165W



MOTORE / MOTOR	M7152 ( 12 V )		M7152 ( 24 V )
Coppia nominale / Rated torque	0.48 Nm		0.52 Nm
Potenza nominale / Rated power	80 W	150 W	165 W
Velocità nominale / Rated speed	1500 min <sup>-1</sup>	3000 min <sup>-1</sup>	3000 min <sup>-1</sup>
Corrente nominale / Rated current	8.5 A	17 A	8.5 A
Tensione nominale / Rated voltage	12 V		24 V
Velocità a vuoto / No load speed	1800 min <sup>-1</sup>	3700 min <sup>-1</sup>	3500 min <sup>-1</sup>
Peso / Weight	2.2 Kg		2.2 Kg
Tolleranza / Tolerance	±10%		

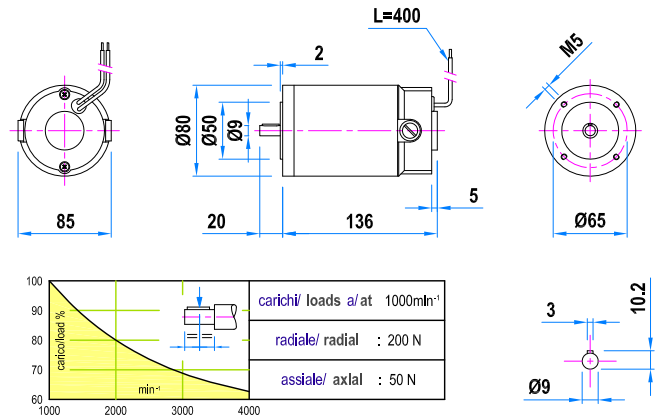

# Motore M7255 IP54

## Motor M7255 IP54

Motori C.C. a norme CEI ed IEC - magnete permanente - 4 poli  
D.C. motors CEI and IEC standards - permanent magnet - 4 poles

Alimentazione da batteria - tensione nominale 12/24V  
Battery supply - rated voltage 12/24V

Fattore di forma 1 - senza ventilazione  
Form factor 1 - no ventilated

Isolamento classe F - protezione IP54  
Insulation F class - protection IP54

Morsetti  
Terminals

S2-S3 SERVIZIO INTERMITTENTE  
INTERMITTENT DUTY

120-345W



MOTORE / MOTOR	M7255.2	
Coppia nominale / Rated torque	1.1 Nm	
Potenza nominale / Rated power	175 W	345 W
Velocità nominale / Rated speed	1500 min <sup>-1</sup>	3000 min <sup>-1</sup>
Corrente nominale / Rated current	20 A	
Tensione nominale / Rated voltage	12 V	24 V
Velocità a vuoto / No load speed	1800 min <sup>-1</sup>	3600 min <sup>-1</sup>
Peso / Weight	2.9 Kg	
Tolleranza / Tolerance	±10%	

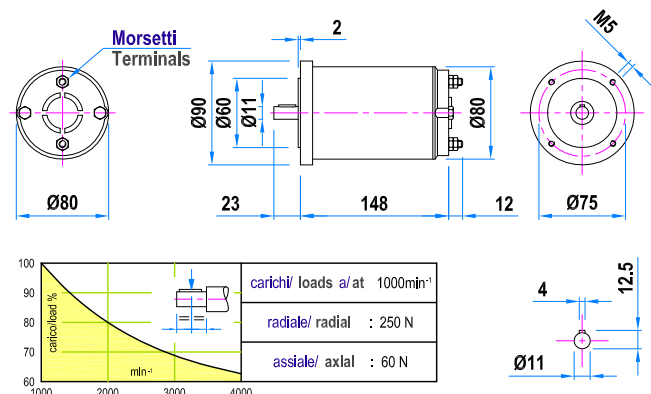

# Motore N505 IP54 - N506 IP66

# Motor N505 IP54 - N506 IP66

60-470W

Motori C.C. a norme CEI ed IEC - magnete permanente - 4 poli  
D.C. motors CEI and IEC standards - permanent magnet - 4 poles

Alimentazione da batteria - tensione nominale 12/24/48V  
Battery supply - rated voltage 12/24/48V

Fattore di forma 1 - servizio S1 e S3 - senza ventilazione  
Form factor 1 - duty S1 and S3 - no ventilated

Protezione IP54 su N505, IP66 su N506 - isolamento classe F / H  
Protection IP54 on N505, IP66 on N506- insulation F / H class

Scatola morsetti  
Terminal box



## Servizio intermittente S3 / Intermittent duty S3

Tipo / Type	1500min <sup>-1</sup>			2000min <sup>-1</sup>			3000min <sup>-1</sup>		
N505.4 N506.4	80 W	12 V - 8.5 A	0.53 Nm	120 W	12 V - 12.8 A	0.53 Nm	165 W	12 V - 17.6 A	0.53 Nm
		24 V - 4.3 A			24 V - 6.4 A			24 V - 8.8 A	
		48 V - 2.1 A			48 V - 3.2 A			48 V - 4.4 A	
N505.5 N506.5	115 W	12 V - 12.3 A	0.75 Nm	175 W	12 V - 18.7 A	0.75 Nm	235 W	12 V - 25.1 A	0.75 Nm
		24 V - 6.1 A			24 V - 9.3 A			24 V - 12.5 A	
		48 V - 3.1 A			48 V - 4.7 A			48 V - 6.3 A	
N505.10 N506.10	235 W	12 V - 25.1 A	1.5 Nm	310 W	12 V - 33 A	1.5 Nm	400 W	12 V - 42.7 A	1.27 Nm
		24 V - 12.5 A			24 V - 16.5 A			24 V - 25.1 A	
		48 V - 6.3 A			48 V - 8.3 A			48 V - 12.5 A	

Tolleranza / Tolerance ±10%

Max. 400 W a / at 12 V

## Servizio continuo S1 / Continuous duty S1

Tipo / Type	1500min <sup>-1</sup>			2000min <sup>-1</sup>			3000min <sup>-1</sup>		
N505.4 N506.4	60 W	12 V - 6.4 A	0.39 Nm	80 W	12 V - 8.5 A	0.39 Nm	120 W	12 V - 12.8 A	0.39 Nm
		24 V - 3.2 A			24 V - 4.3 A			24 V - 6.4 A	
		48 V - 1.6 A			48 V - 2.1 A			48 V - 3.2 A	
N505.5 N506.5	85 W	12 V - 9.1 A	0.55 Nm	115 W	12 V - 12.3 A	0.55 Nm	170 W	12 V - 18.2 A	0.55 Nm
		24 V - 4.5 A			24 V - 6.1 A			24 V - 9.1 A	
		48 V - 2.3 A			48 V - 3.1 A			48 V - 4.5 A	
N505.10 N506.10	170 W	12 V - 18.2 A	1.1 Nm	230 W	12 V - 24.6 A	1.1 Nm	340 W	12 V - 36.4 A	1.1 Nm
		24 V - 9.1 A			24 V - 12.3 A			24 V - 18.2 A	
		48 V - 4.5 A			48 V - 6.1 A			48 V - 9.1 A	

Tolleranza / Tolerance ±10%

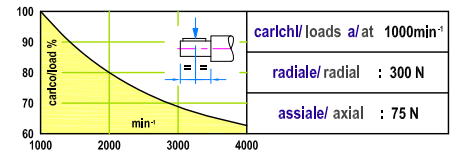
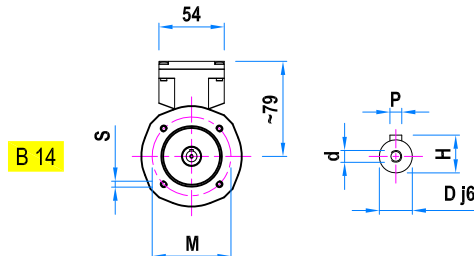
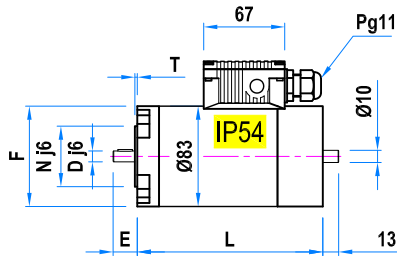

Tipo / Type	L	Peso / Weight
N505.4 N506.4	138.5	2.4 Kg
N505.5 N506.5	153.5	2.7 Kg
N505.10 N506.10	200.5	4.3 Kg

### Alberi / Shafts

D	E	P	H	d
Ø9	20	3x3x12	10.2	M3
Ø11	23	4x4x15	12.5	M4

### Flange B14 / Flanges B14

F	N	M	T	S
Ø80	Ø50	Ø65	2	M5
Ø90	Ø60	Ø75	2	M5

# Motore LN56 IP54

## Motor LN56 IP54

**S1** SERVIZIO CONTINUO  
CONTINUOUS DUTY **85-500W**

Motori C.C. a norme CEI ed IEC - magnete permanente - 2 poli  
D.C. motors CEI and IEC standards - permanent magnet - 2 poles

Alimentazione da batteria - tensione nominale 12/24/48V  
Battery supply - rated voltage 12/24/48V

Fattore di forma 1 - senza ventilazione  
Form factor 1 - no ventilated

Protezione IP54 - isolamento classe F / H  
Protection IP54 - insulation F / H class

Scatola morsetti o uscita cavo  
Terminal box or free cable



Tipo / Type	1500min <sup>-1</sup>			2000min <sup>-1</sup>			3000min <sup>-1</sup>		
LN56.5	85 W	12 V - 9.1 A	0.53 Nm	110 W	12 V - 11.8 A	0.53 Nm	165 W	12 V - 17.6 A	0.53 Nm
		24 V - 4.5 A			24 V - 5.9 A			24 V - 8.8 A	
		48 V - 2.3 A			48 V - 2.9 A			48 V - 4.4 A	
LN56.10	165 W	12 V - 17.6 A	1 Nm	200 W	12 V - 22 A	0.95 Nm	200 W	12 V - 22 A	0.64 Nm
		24 V - 8.8 A		220 W	24 V - 11.8 A		330 W	24 V - 17.6 A	
		48 V - 4.4 A		48 V - 5.9 A	48 V - 8.8 A		1 Nm		
LN56.15	200 W	12 V - 22 A	1.3 Nm	--	--	--	--	--	--
	250 W	24 V - 13.5 A	1.6 Nm	330 W	24 V - 17.6 A	1.6 Nm	400 W	24 V - 22 A	1.3 Nm
		48 V - 6.7 A			48 V - 8.8 A		500 W	48 V - 13.5 A	1.6 Nm

Tolleranza / Tolerance ±10%

Max. 200 W a / at 12 V

Max. 400 W a / at 24 V

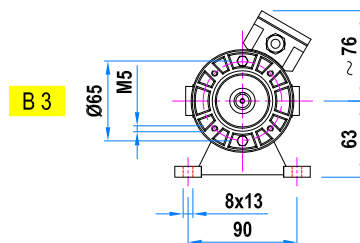
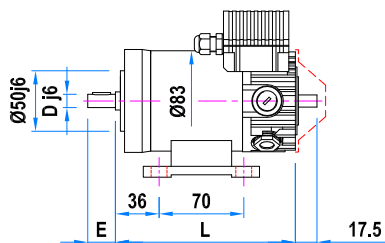
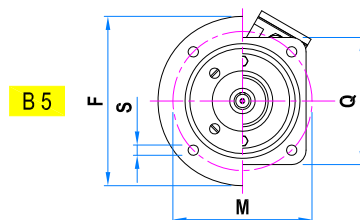
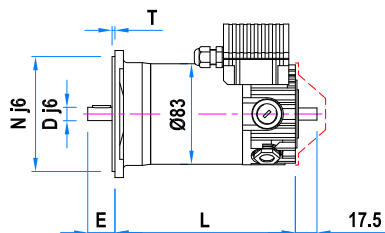
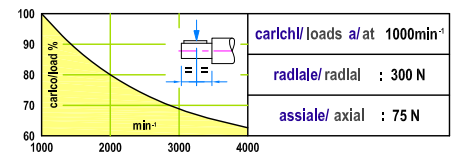
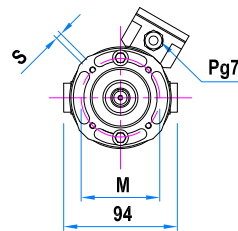
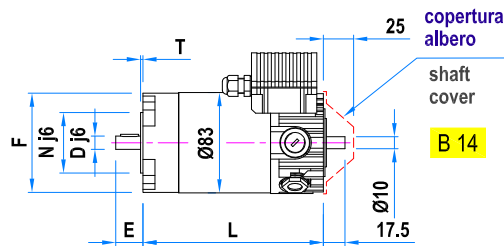

Tipo / Type	L	Peso / Weight
LN56.5	149	2.7 Kg
LN56.10	196	4.3 Kg
LN56.15	241	5.6 Kg

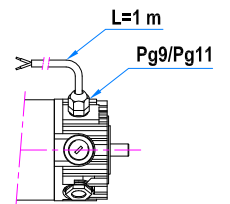

Uscita cavo / Free cable

Flange B14 / Flanges B14				
F	N	M	T	S
Ø80	Ø50	Ø65	2	M5
Ø90	Ø60	Ø75	2	M5
Ø105	Ø70	Ø85	2	M6

Flange B5 / Flanges B5					
F	Q	N	M	T	S
Ø120	90	Ø80	Ø100	3	Ø6.5
--	105	Ø95	Ø115	2.5	Ø9
--	120	Ø110	Ø130	2.5	Ø9

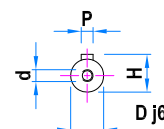

Alberi / Shafts				
D	E	P	H	d
Ø9	20	3x3x12	10.2	M3
Ø11	23	4x4x15	12.5	M4
Ø14	30	5x5x20	16	M5

# Motore LV56 IP54

## Motor LV56 IP54

**S1** SERVIZIO CONTINUO  
CONTINUOUS DUTY

**100-600W**

Motori C.C. a norme CEI ed IEC - magnete permanente - 2 poli  
D.C. motors CEI and IEC standards - permanent magnet - 2 poles

Alimentazione da batteria - tensione nominale 12/24/48V  
Battery supply - rated voltage 12/24/48V

Fattore di forma 1 - autoventilato  
Form factor 1 - selfventilated

Protezione IP54 - isolamento classe F / H  
Protection IP54 - insulation F / H class

Scatola morsetti o uscita cavo  
Terminal box or free cable



Tipo / Type	1500min <sup>-1</sup>			2000min <sup>-1</sup>			3000min <sup>-1</sup>						
LV56.5	100 W	12 V - 11 A	0.64 Nm	135 W	12 V - 14.5 A	0.64 Nm	200 W	12 V - 22 A	0.64 Nm				
		24 V - 5.5 A			24 V - 7.2 A			24 V - 11 A					
		48 V - 2.7 A			48 V - 3.6 A			48 V - 5.5 A					
LV56.10	200 W	12 V - 22 A	1.3 Nm	200 W	12 V - 22 A	0.95 Nm	200 W	12 V - 22 A	0.64 Nm				
		24 V - 11 A			24 V - 14.5 A			24 V - 22 A					
		48 V - 5.5 A			48 V - 7.2 A			48 V - 11 A					
LV56.15	200 W	12 V - 22 A	1.3 Nm	--	--	--	--	--	--				
		24 V - 16 A								24 V - 22 A	400 W	24 V - 22 A	1.3 Nm
		48 V - 8 A								48 V - 11 A	400 W	48 V - 16 A	1.9 Nm

Tolleranza / Tolerance ±10%

Max. 200 W a / at 12 V

Max. 400 W a / at 24 V

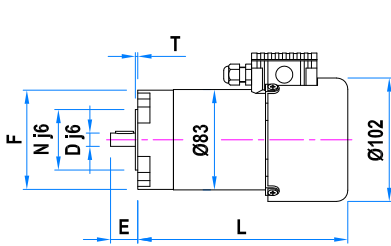

B 14

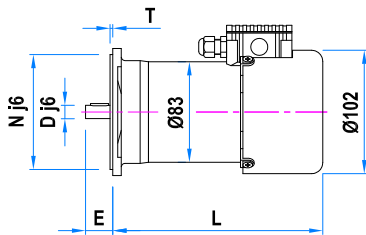
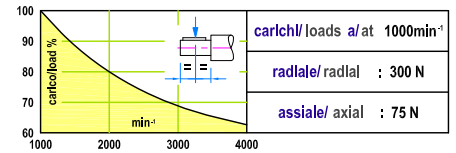
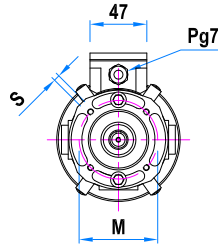

B 5

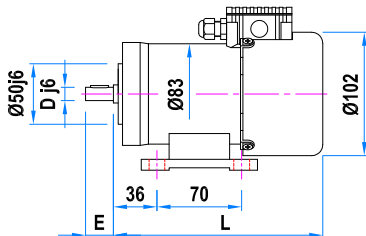
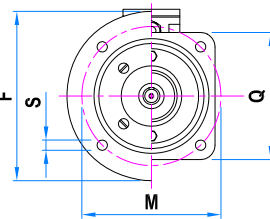

B 3

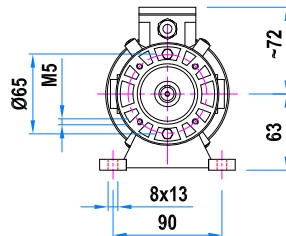

Tipo / Type	L	Peso / Weight
LV56.5	174	3.2 Kg
LV56.10	221	4.8 Kg
LV56.15	266	6.1 Kg

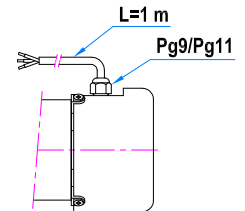

Uscita cavo / Free cable

Flange B14 / Flanges B14				
F	N	M	T	S
Ø80	Ø50	Ø65	2	M5
Ø90	Ø60	Ø75	2	M5
Ø105	Ø70	Ø85	2	M6

Flange B5 / Flanges B5					
F	Q	N	M	T	S
Ø120	90	Ø80	Ø100	3	Ø6.5
--	105	Ø95	Ø115	2.5	Ø9
--	120	Ø110	Ø130	2.5	Ø9

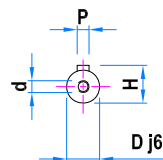

Alberi / Shafts				
D	E	P	H	d
Ø9	20	3x3x12	10.2	M3
Ø11	23	4x4x15	12.5	M4
Ø14	30	5x5x20	16	M5

# Motore LN70 IP54 o IP66

## Motor LN70 IP54 or IP66

**S1** SERVIZIO CONTINUO  
CONTINUOUS DUTY **160-760W**

Motori C.C. a norme CEI ed IEC - magnete permanente - 4 poli  
D.C. motors CEI and IEC standards - permanent magnet - 4 poles

Alimentazione da batteria - tensione nominale 12/24/48V  
Battery supply - rated voltage 12/24/48V

Fattore di forma 1 - senza ventilazione  
Form factor 1 - no ventilated

Isolamento classe F / H - protezione IP54 ( a richiesta IP66 )  
Insulation F / H class - protection IP54 ( IP66 on request )

Uscita cavo  
Free cable



Tipo / Type	1500min <sup>-1</sup>			2000min <sup>-1</sup>			3000min <sup>-1</sup>		
LN70.5	160 W	12 V - 17 A	1 Nm	215 W	12 V - 22 A	1 Nm	320 W	12 V - 34 A	1 Nm
		24 V - 8.5 A			24 V - 11 A			24 V - 17 A	
		48 V - 4.2 A			48 V - 5.5 A			48 V - 8.5 A	
LN70.10	270 W	12 V - 28 A	1.7 Nm	360 W	12 V - 38 A	1.7 Nm	400 W	12 V - 41 A	1.2 Nm
		24 V - 14 A			24 V - 19 A		540 W	24 V - 28 A	1.7 Nm
		48 V - 7 A			48 V - 9.5 A		48 V - 14 A		
LN70.15	380 W	12 V - 40 A	2.4 Nm	380 W	12 V - 40 A	1.8 Nm	--	--	--
		24 V - 20 A		500 W	24 V - 26 A		760 W	24 V - 40 A	2.4 Nm
		48 V - 10 A		48 V - 13 A	48 V - 20 A				

Tolleranza / Tolerance ±10%

Max. 400 W a / at 12 V

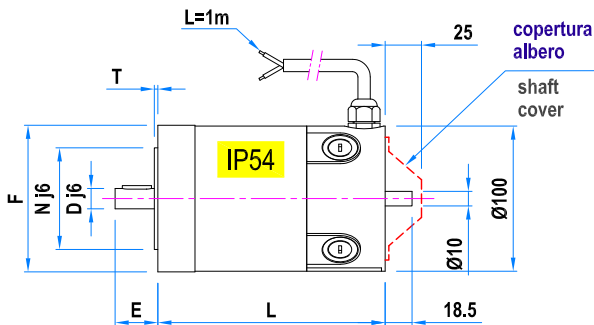

B 14

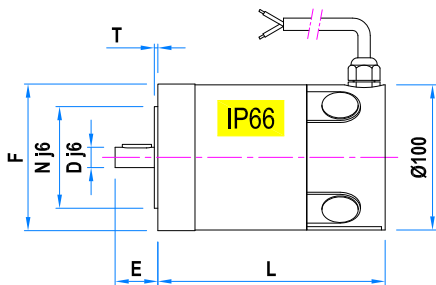
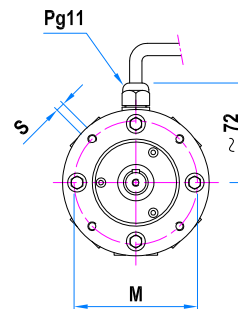

B 14

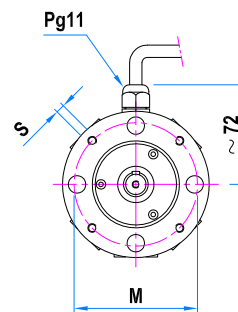

Flange B14 / Flanges B14				
F	N	M	T	S
Ø90	Ø60	Ø75	2	M5
Ø105	Ø70	Ø85	2.5	M6

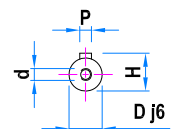

Tipo / Type	L	Peso / Weight
LN70.5	156.5	4.2 Kg
LN70.10	206.5	6.2 Kg
LN70.15	256.5	8.3 Kg

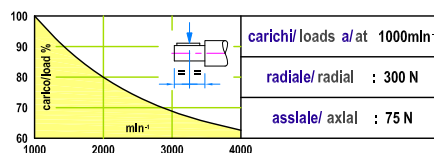

Alberi / Shafts				
D	E	P	H	d
Ø11	23	4x4x15	12.5	M4
Ø14	30	5x5x20	16	M5



# Motore M71\_3 IP54

## Motor M71\_3 IP54

# Motore MV71\_3 IP23

## Motor MV71\_3 IP23

180-360W

Motori C.C. a norme CEI ed IEC - magnete permanente - 2 o 4 poli  
D.C. motors CEI and IEC standards - permanent magnet - 2 or 4 poles

Alimentazione da batteria - tensione nominale 12/24/48V - fattore di forma 1  
Battery supply - rated voltage 12/24/48V - form factor 1

Tipo M senza ventilazione - servizio intermittente S2/S3 - prot. IP54 - isol. cl. F/H  
M type no ventilated - intermittent duty S2/S3 - protection IP54 - insul. F/H class

Tipo MV autoventilato - servizio continuo S1 - prot. IP23 - isol. classe F/H  
MV type selfventilated - continuous duty S1 - protection IP23 - insul. F/H class

Fili uscenti  
Free wires



### Tipo M senza ventilazione - Servizio intermittente S2/S3

### M type no ventilated - Intermittent duty S2/S3

Tipo / Type	1500min <sup>-1</sup>			2000min <sup>-1</sup>			3000min <sup>-1</sup>		
M71_3	180 W	12 V - 19 A	1.15 Nm	240 W	12 V - 26 A	1.15 Nm	360 W	12 V - 38 A	
		24 V - 9 A			24 V - 12 A			24 V - 18 A	
		48 V - 4.5 A			48 V - 6 A			48 V - 9 A	

### Tipo MV autoventilato - Servizio continuo S1

### MV type no ventilated - Continuous duty S1

Tipo / Type	1500min <sup>-1</sup>			2000min <sup>-1</sup>			3000min <sup>-1</sup>		
MV71_3	180 W	12 V - 19 A	1.15 Nm	240 W	12 V - 26 A	1.15 Nm	360 W	12 V - 38 A	
		24 V - 9 A			24 V - 12 A			24 V - 18 A	
		48 V - 4.5 A			48 V - 6 A			48 V - 9 A	

Tolleranza / Tolerance ±10%

Tipo / Type 712.3 2 poli / 2 poles

Tipo / Type 714.3 4 poli / 4 poles

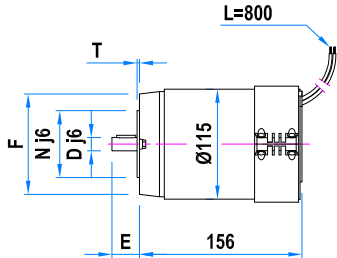

B 14

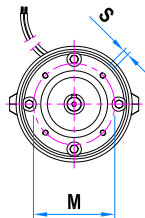

#### Flange B14 / Flanges B14

F	N	M	T	S
Ø90	Ø60	Ø75	2.5	M5
Ø105	Ø70	Ø85	2.5	M6

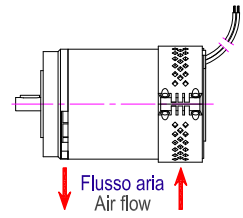

Tipo MV / MV type Autoventilato / Selfventilated

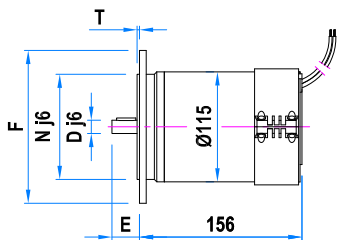

B 5

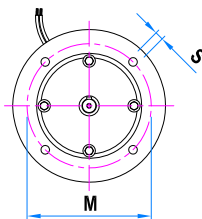

#### Flange B5 / Flanges B5

F	N	M	T	S
Ø140	Ø95	Ø115	2.5	Ø9
Ø160	Ø110	Ø130	2.5	Ø9

#### Piedi B3 / Feet B3

h	W	A	B	G
63	25	100	80	7x10
71	20	112	90	7x12

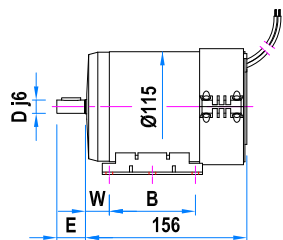

B 3

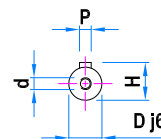
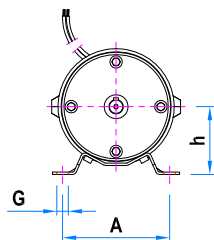

#### Alberi / Shafts

D	E	P	H	d
Ø11	23	4x4x15	12.5	M4
Ø14	30	5x5x20	16	M5

#### Peso / Weight

4.6 Kg

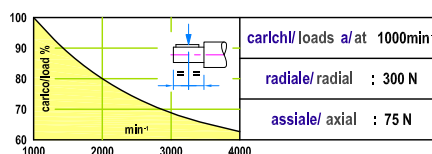

# Motore M71\_5 IP54

## Motor M71\_5 IP54

# Motore MV71\_5 IP23

## Motor MV71\_5 IP23

250-500W

Motori C.C. a norme CEI ed IEC - magnete permanente - 2 o 4 poli  
 D.C. motors CEI and IEC standards - permanent magnet - 2 or 4 poles  
 Alimentazione da batteria - tensione nominale 12/24/48V - fattore di forma 1  
 Battery supply - rated voltage 12/24/48V - form factor 1

Tipo M senza ventilazione - servizio intermittente S2/S3 - prot. IP54 - isol. cl. F/H  
 M type no ventilated - intermittent duty S2/S3 - protection IP54 - insul. F/H class  
 Tipo MV autoventilato - servizio continuo S1 - prot. IP23 - isol. classe F/H  
 MV type selfventilated - continuous duty S1 - protection IP23 - insul. F/H class

Fili uscenti  
 Free wires



### Tipo M senza ventilazione - Servizio intermittente S2/S3

### M type no ventilated - Intermittent duty S2/S3

Tipo / Type	1500min <sup>-1</sup>			2000min <sup>-1</sup>			3000min <sup>-1</sup>		
M71_5	250 W	12 V - 26 A	1.6 Nm	340 W	12 V - 36 A	1.6 Nm	400 W	12 V - 43 A	1.3 Nm
		24 V - 12 A			24 V - 17 A		500 W	24 V - 25 A	1.6 Nm
		48 V - 6 A			48 V - 8 A			48 V - 12 A	

### Tipo MV autoventilato - Servizio continuo S1

### MV type no ventilated - Continuous duty S1

Tipo / Type	1500min <sup>-1</sup>			2000min <sup>-1</sup>			3000min <sup>-1</sup>		
MV71_5	250 W	12 V - 26 A	1.6 Nm	340 W	12 V - 36 A	1.6 Nm	400 W	12 V - 43 A	1.3 Nm
		24 V - 12 A			24 V - 17 A		500 W	24 V - 25 A	1.6 Nm
		48 V - 6 A			48 V - 8 A			48 V - 12 A	

Tolleranza / Tolerance ±10% Max. 400 W a/at 12 V

Tipo / Type 712.5 2 poli / 2 poles Tipo / Type 714.5 4 poli / 4 poles

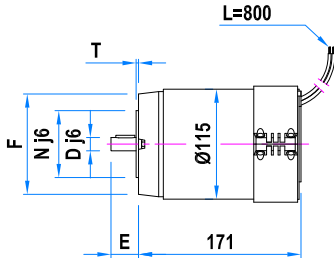

B 14

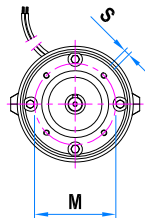

#### Flange B14 / Flanges B14

F	N	M	T	S
Ø90	Ø60	Ø75	2.5	M5
Ø105	Ø70	Ø85	2.5	M6

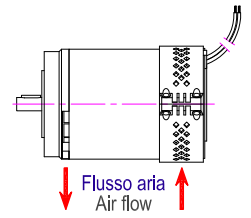

Tipo MV / MV type Autoventilato / Selfventilated

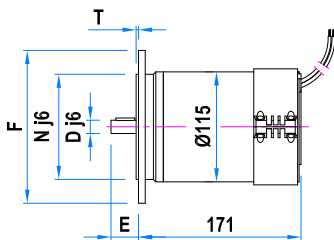

B 5

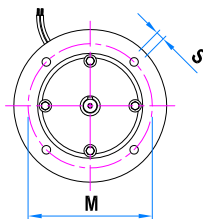

#### Flange B5 / Flanges B5

F	N	M	T	S
Ø140	Ø95	Ø115	2.5	Ø9
Ø160	Ø110	Ø130	2.5	Ø9

#### Piedi B3 / Feet B3

h	W	A	B	G
63	40	100	80	7x10
71	25	112	90	7x12

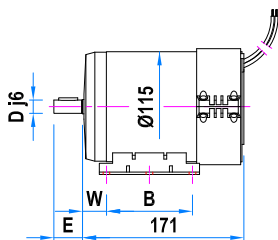

B 3

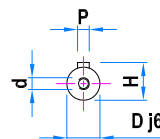
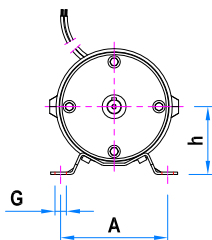

#### Alberi / Shafts

D	E	P	H	d
Ø11	23	4x4x15	12.5	M4
Ø14	30	5x5x20	16	M5

Peso / Weight  
 5.7 Kg

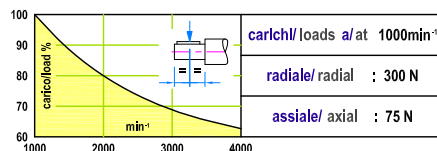

# Motore M71\_7 IP54

## Motor M71\_7 IP54

# Motore MV71\_7 IP23

## Motor MV71\_7 IP23

300-600W

Motori C.C. a norme CEI ed IEC - magnete permanente - 2 o 4 poli  
D.C. motors CEI and IEC standards - permanent magnet - 2 or 4 poles

Alimentazione da batteria - tensione nominale 12/24/48V - fattore di forma 1  
Battery supply - rated voltage 12/24/48V - form factor 1

Tipo M senza ventilazione - servizio intermittente S2/S3 - prot. IP54 - isol. cl. F/H  
M type no ventilated - intermittent duty S2/S3 - protection IP54 - insul. F/H class

Tipo MV autoventilato - servizio continuo S1 - prot. IP23 - isol. classe F/H  
MV type selfventilated - continuous duty S1 - protection IP23 - insul. F/H class

Fili uscenti  
Free wires



### Tipo M senza ventilazione - Servizio intermittente S2/S3

### M type no ventilated - Intermittent duty S2/S3

Tipo / Type	1500min <sup>-1</sup>			2000min <sup>-1</sup>			3000min <sup>-1</sup>		
M71_7	300 W	12 V - 31 A	1.9 Nm	400 W	12 V - 43 A	1.9 Nm	--	--	--
		24 V - 15 A			24 V - 20 A		600 W	24 V - 30 A	1.9 Nm
		48 V - 7.5 A			48 V - 10 A		48 V - 15 A		

### Tipo MV autoventilato - Servizio continuo S1

### MV type no ventilated - Continuous duty S1

Tipo / Type	1500min <sup>-1</sup>			2000min <sup>-1</sup>			3000min <sup>-1</sup>		
MV71_7	300 W	12 V - 31 A	1.9 Nm	400 W	12 V - 43 A	1.9 Nm	--	--	--
		24 V - 15 A			24 V - 20 A		600 W	24 V - 30 A	1.9 Nm
		48 V - 7.5 A			48 V - 10 A		48 V - 15 A		

Tolleranza / Tolerance ±10% Max. 400 W a/at 12 V

Tipo / Type 712.7 2 poli / 2 poles Tipo / Type 714.7 4 poli / 4 poles

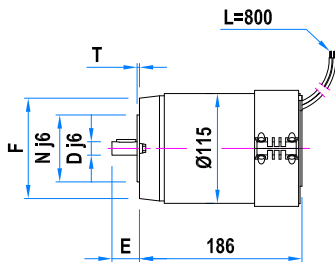

B 14

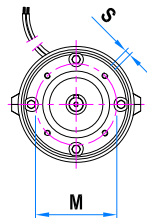

Flange B14 / Flanges B14				
F	N	M	T	S
Ø90	Ø60	Ø75	2.5	M5
Ø105	Ø70	Ø85	2.5	M6

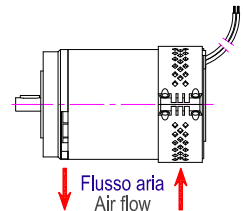

Tipo MV / MV type Autoventilato / Selfventilated

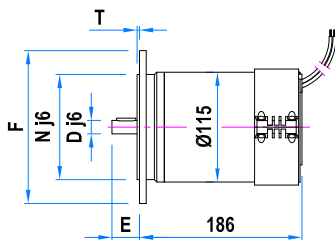

B 5

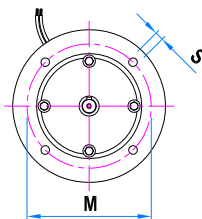

Flange B5 / Flanges B5				
F	N	M	T	S
Ø140	Ø95	Ø115	2.5	Ø9
Ø160	Ø110	Ø130	2.5	Ø9

Piedi B3 / Feet B3				
h	W	A	B	G
63	40	100	80	7x10
71	45	112	90	7x12

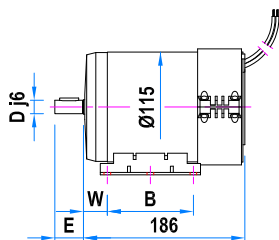

B 3

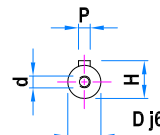
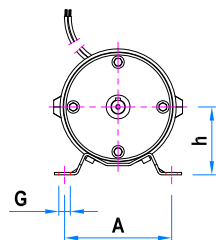

Alberi / Shafts				
D	E	P	H	d
Ø11	23	4x4x15	12.5	M4
Ø14	30	5x5x20	16	M5

Peso / Weight  
6.5 Kg

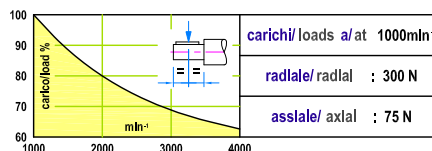

# Motore M71\_9 IP54

## Motor M71\_9 IP54

# Motore MV71\_9 IP23

## Motor MV71\_9 IP23

400-850W

Motori C.C. a norme CEI ed IEC - magnete permanente - 2 o 4 poli  
 D.C. motors CEI and IEC standards - permanent magnet - 2 or 4 poles  
 Alimentazione da batteria - tensione nominale 12/24/48V - fattore di forma 1  
 Battery supply - rated voltage 12/24/48V - form factor 1

Tipo M senza ventilazione - servizio intermittente S2/S3 - prot. IP54 - isol. cl. F/H  
 M type no ventilated - intermittent duty S2/S3 - protection IP54 - insul. F/H class  
 Tipo MV autoventilato - servizio continuo S1 - prot. IP23 - isol. classe F/H  
 MV type selfventilated - continuous duty S1 - protection IP23 - insul. F/H class

Fili uscenti  
 Free wires



### Tipo M senza ventilazione - Servizio intermittente S2/S3

### M type no ventilated - Intermittent duty S2/S3

Tipo / Type	1500min <sup>-1</sup>			2000min <sup>-1</sup>			3000min <sup>-1</sup>		
M71_9	400 W	12 V - 43 A	2.6 Nm	--	--	--	--	--	--
	450 W	24 V - 23 A	2.9 Nm	600 W	24 V - 30 A	2.9 Nm	850 W	24 V - 43 A	2.7 Nm
		48 V - 11 A			48 V - 15 A			48 V - 22 A	

### Tipo MV autoventilato - Servizio continuo S1

### MV type no ventilated - Continuous duty S1

Tipo / Type	1500min <sup>-1</sup>			2000min <sup>-1</sup>			3000min <sup>-1</sup>		
MV71_9	400 W	12 V - 43 A	2.6 Nm	--	--	--	--	--	--
	450 W	24 V - 23 A	2.9 Nm	600 W	24 V - 30 A	2.9 Nm	850 W	24 V - 43 A	2.7 Nm
		48 V - 11 A			48 V - 15 A			48 V - 22 A	

Tolleranza / Tolerance ±10% Max. 400 W a / at 12 V

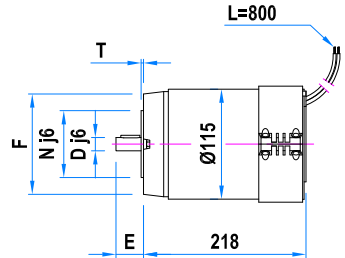

B 14

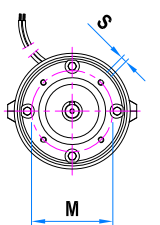

Flange B14 / Flanges B14				
F	N	M	T	S
Ø90	Ø60	Ø75	2.5	M5
Ø105	Ø70	Ø85	2.5	M6

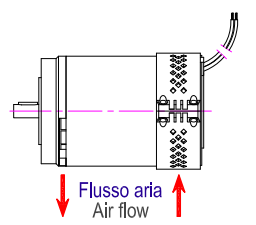

Tipo MV / MV type Autoventilato / Selfventilated

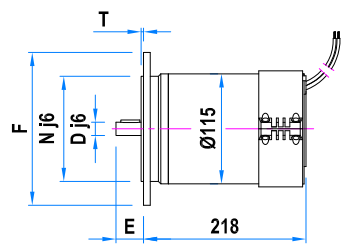

B 5

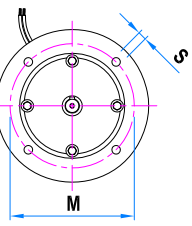

Flange B5 / Flanges B5				
F	N	M	T	S
Ø140	Ø95	Ø115	2.5	Ø9
Ø160	Ø110	Ø130	2.5	Ø9

Piedi B3 / Feet B3				
h	W	A	B	G
63	40	100	80	7x10
71	45	112	90	7x12

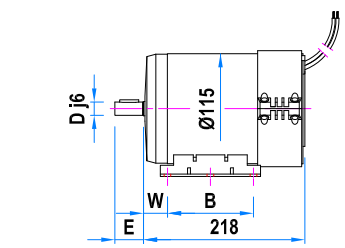

B 3

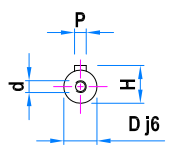
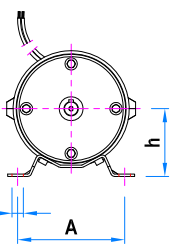

Alberi / Shafts				
D	E	P	H	d
Ø11	23	4x4x15	12.5	M4
Ø14	30	5x5x20	16	M5

Peso / Weight  
 8.5 Kg

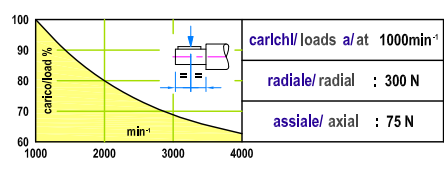

# Motore M71\_.13 IP54

## Motor M71\_.13 IP54

# Motore MV71\_.13 IP23

## Motor MV71\_.13 IP23

600-1200W

Motori C.C. a norme CEI ed IEC - magnete permanente - 2 o 4 poli  
D.C. motors CEI and IEC standards - permanent magnet - 2 or 4 poles

Alimentazione da batteria - tensione nominale 12/24/48V - fattore di forma 1  
Battery supply - rated voltage 12/24/48V - form factor 1

Tipo M senza ventilazione - servizio intermittente S2/S3 - prot. IP54 - isol. cl. F/H  
M type no ventilated - intermittent duty S2/S3 - protection IP54 - insul. F/H class

Tipo MV autoventilato - servizio continuo S1 - prot. IP23 - isol. classe F/H  
MV type selfventilated - continuous duty S1 - protection IP23 - insul. F/H class

Fili uscenti  
Free wires



### Tipo M senza ventilazione - Servizio intermittente S2/S3

### M type no ventilated - Intermittent duty S2/S3

Tipo / Type	1500min <sup>-1</sup>			2000min <sup>-1</sup>			3000min <sup>-1</sup>		
M71_.13	--	--	--	--	--	--	--	--	--
	600 W	24 V - 30 A	3.8 Nm	800 W	24 V - 40 A	3.8 Nm	--	--	--
		48 V - 15 A			1200 W		48 V - 30 A	3.8 Nm	

### Tipo MV autoventilato - Servizio continuo S1

### MV type no ventilated - Continuous duty S1

Tipo / Type	1500min <sup>-1</sup>			2000min <sup>-1</sup>			3000min <sup>-1</sup>		
MV71_.13	--	--	--	--	--	--	--	--	--
	600 W	24 V - 30 A	3.8 Nm	800 W	24 V - 40 A	3.8 Nm	--	--	--
		48 V - 15 A			1200 W		48 V - 30 A	3.8 Nm	

Tolleranza / Tolerance ±10%    Max. 400 W a / at 12 V    Max. 800 W a / at 24 V    Tipo / Type 712.13 2 poli / 2 poles    Tipo / Type 714.13 4 poli / 4 poles

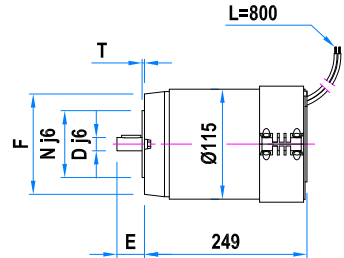

B 14

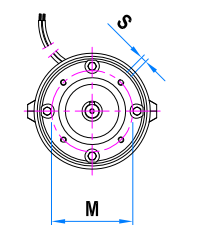

Flange B14 / Flanges B14				
F	N	M	T	S
Ø90	Ø60	Ø75	2.5	M5
Ø105	Ø70	Ø85	2.5	M6

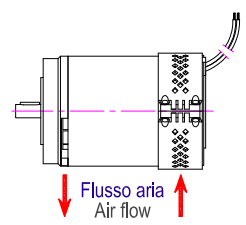

Tipo MV / MV type Autoventilato / Selfventilated

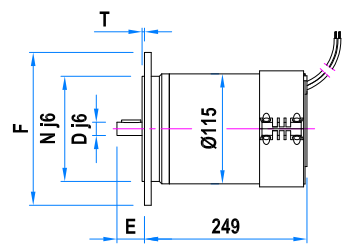

B 5

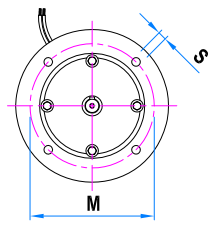

Flange B5 / Flanges B5				
F	N	M	T	S
Ø140	Ø95	Ø115	2.5	Ø9
Ø160	Ø110	Ø130	2.5	Ø9

Piedi B3 / Feet B3				
h	W	A	B	G
63	40	100	80	7x10
71	45	112	90	7x12

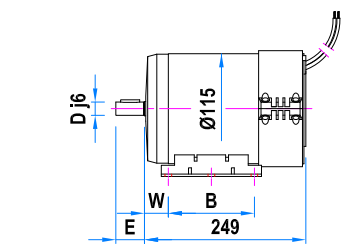

B 3

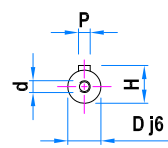
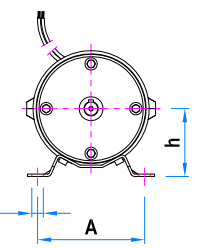

Alberi / Shafts				
D	E	P	H	d
Ø11	23	4x4x15	12.5	M4
Ø14	30	5x5x20	16	M5

Peso / Weight  
11.5 Kg

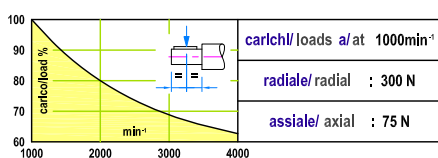

# Motore N745 IP55 - N746 IP66

## Motor N745 IP55 - N746 IP66

**S1** SERVIZIO CONTINUO  
CONTINUOUS DUTY

**0,3-1,3kW**

Motori C.C. a norme CEI ed IEC - magnete permanente - 4 poli  
D.C. motors CEI and IEC standards - permanent magnet - 4 poles

Alimentazione da batteria - tensione nominale 12/24/48V  
Battery supply - rated voltage 12/24/48V

Fattore di forma 1 - senza ventilazione  
Form factor 1 - no ventilated

N745 protezione IP55 - N746 protezione IP66 - isolamento classe F / H  
N745 protection IP55 - N746 protection IP66 - insulation F / H class

N745 scatola morsetti o uscita cavo - N746 solo uscita cavo senza albero posteriore  
N745 terminal box or free cable - N746 only free cable without back shaft



Tipo / Type	1500min <sup>-1</sup>			2000min <sup>-1</sup>			3000min <sup>-1</sup>		
N745.6 N746.6	0,3 kW	12 V - 32 A	2 Nm	0,4 kW	12 V - 43 A	2 Nm	0,55 kW	12 V - 59 A	1,8 Nm
24 V - 16 A		24 V - 21,5 A			24 V - 29,5 A				
48 V - 8 A		48 V - 10,7 A			48 V - 14,7 A				
N745.9 N746.9	0,4 kW	12 V - 43 A	2,7 Nm	0,55 kW	12 V - 59 A	2,7 Nm	0,75 kW	12 V - 80 A	2,4 Nm
24 V - 21,5 A		24 V - 29,5 A			24 V - 40 A				
48 V - 10,7 A		48 V - 14,7 A			48 V - 20 A				
N745.12 N746.12	0,55 kW	12 V - 59 A	3,6 Nm	0,75 kW	12 V - 80 A	3,6 Nm	0,75 kW	12 V - 80 A	2,4 Nm
24 V - 29,5 A		24 V - 40 A			24 V - 53,5 A				
48 V - 14,7 A		48 V - 20 A			48 V - 26,7 A		1 kW	3,2 Nm	
N745.18	0,75 kW	12 V - 80 A	4,8 Nm	0,75 kW	12 V - 80 A	3,6 Nm			--
N746.18	0,8 kW	24 V - 43 A	5,1 Nm	1,05 kW	24 V - 56 A	5,1 Nm	1,3 kW	24 V - 70 A	4,2 Nm
		48 V - 21,5 A			48 V - 28 A			48 V - 34,7 A	

Tolleranza / Tolerance ±10%

Max. 0,75 kW a / at 12 V Max. 1,3 kW a / at 24 V

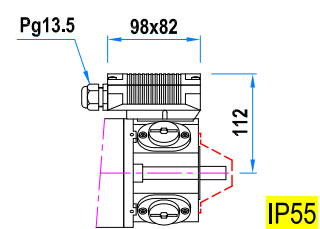
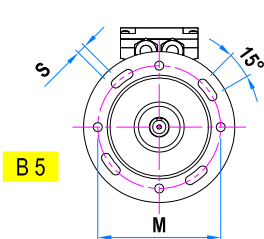
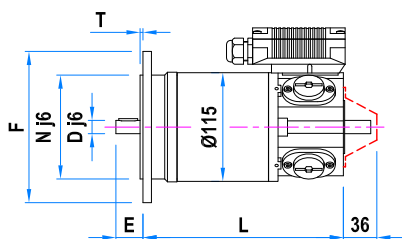
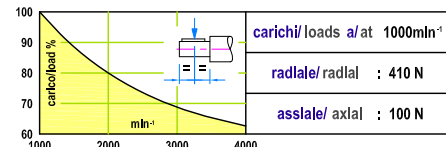
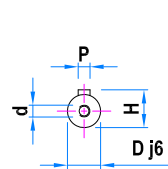
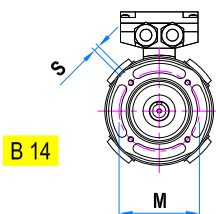
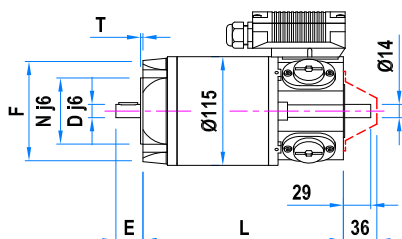

Morsettiera / Terminal box

Alberi / Shafts				
D	E	P	H	d
Ø14	30	5x5x20	16	M5
Ø19	40	6x6x30	21.5	M6

Flange B14 / Flanges B14				
F	N	M	T	S
Ø105	Ø70	Ø85	2,5	M6
Ø120	Ø80	Ø100	2,5	M6

Flange B5 / Flanges B5				
F	N	M	T	S
Ø160	Ø110	Ø130	3	Ø9.5
Ø200	Ø130	Ø165	3	Ø11

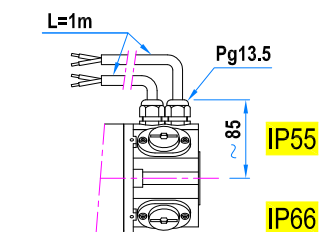
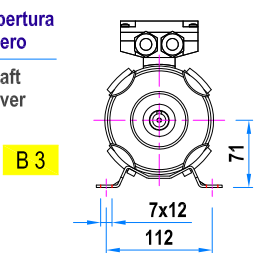
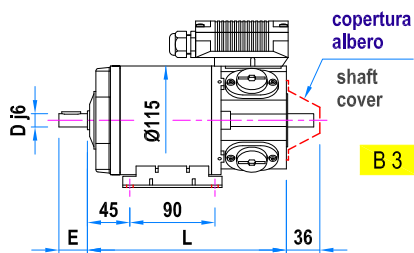

Uscita cavo / Free cable

Tipo / Type	L	Peso / Weight
N745.6 N746.6	214	7.7 Kg
N745.9 N746.9	247	9.7 Kg
N745.12 N746.12	277	11.7 Kg
N745.18 N746.18	337	15.7 Kg

# Motore V745

## Motor V745

IP55 - V746 IP66  
IP55 - V746 IP66

**S1** SERVIZIO CONTINUO  
CONTINUOUS DUTY **0,4-1,8kW**

Motori C.C. a norme CEI ed IEC - magnete permanente - 4 poli  
D.C. motors CEI and IEC standards - permanent magnet - 4 poles

Alimentazione da batteria - tensione nominale 12/24/48V  
Battery supply - rated voltage 12/24/48V

Fattore di forma 1 - senza ventilazione  
Form factor 1 - no ventilated

V745 protezione IP55 - V746 protezione IP66 - isolamento classe F / H  
V745 protection IP55 - V746 protection IP66 - insulation F / H class

V745 scatola morsetti o uscita cavo - V746 solo uscita cavo  
V745 terminal box or free cable - V746 only free cable



Tipo / Type	1500min <sup>-1</sup>			2000min <sup>-1</sup>			3000min <sup>-1</sup>		
V745.6	0,4 kW	12 V - 40 A	2,6 Nm	0,55 kW	12 V - 58 A	2,6 Nm	0,75 kW	12 V - 80 A	2,3 Nm
V746.6		24 V - 20 A			24 V - 29 A			24 V - 40 A	
		48 V - 10 A			48 V - 14,5 A			48 V - 20 A	
V745.9	0,55 kW	12 V - 58 A	3,5 Nm	0,75 kW	12 V - 80 A	3,5 Nm	1 kW	12 V - 80 A	2,3 Nm
V746.9		24 V - 29 A			24 V - 40 A			24 V - 53,5 A	
		48 V - 14,5 A			48 V - 20 A			48 V - 26,5 A	
V745.12	0,75 kW	12 V - 80 A	4,8 Nm	0,75 kW	12 V - 80 A	4,8 Nm	--	--	--
V746.12		24 V - 40 A		1 kW	24 V - 53,5 A		1,3 kW	24 V - 70 A	
		48 V - 20 A		--	48 V - 26,5 A		--	48 V - 35 A	
V745.18	0,75 kW	12 V - 80 A	4,8 Nm	--	--	--	--	--	--
V746.18	1 kW	24 V - 53,5 A	6,4 Nm	1,3 kW	24 V - 70 A	6,4 Nm	1,5 kW	24 V - 80 A	4,8 Nm
		48 V - 26,5 A			--		48 V - 35 A	--	48 V - 48 A

Tolleranza / Tolerance ±10%

Max. 0,75 kW a / at 12 V Max. 1,5 kW a / at 24 V

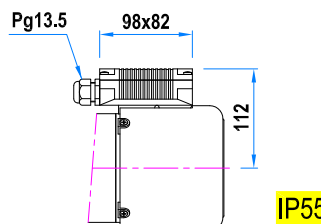
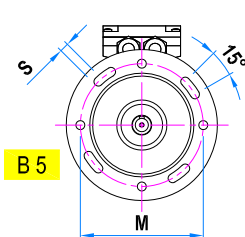
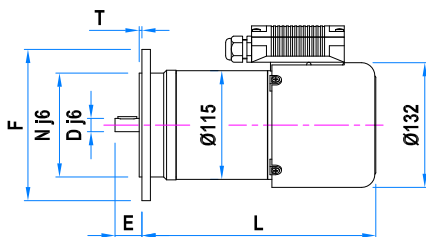
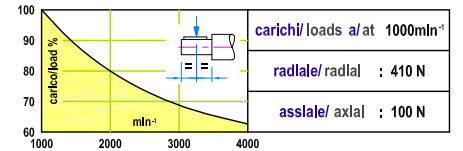
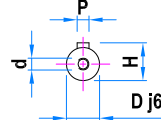
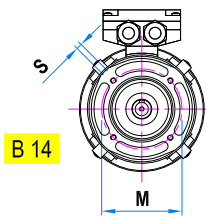
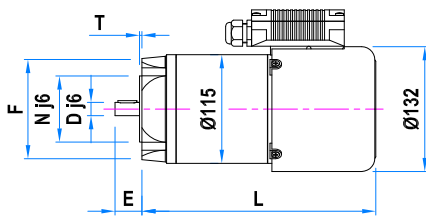

Morsettiera / Terminal box

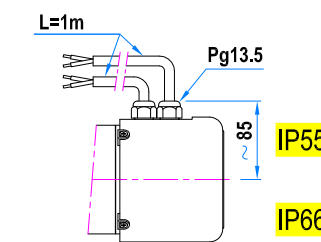
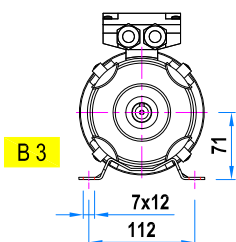
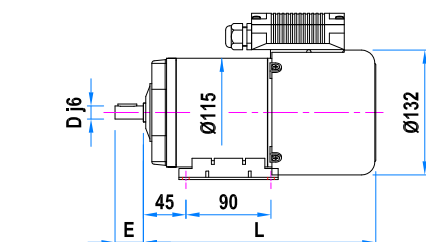

Uscita cavo / Free cable

Alberi / Shafts				
D	E	P	H	d
Ø14	30	5x5x20	16	M5
Ø19	40	6x6x30	21,5	M6

Flange B14 / Flanges B14				
F	N	M	T	S
Ø105	Ø70	Ø85	2,5	M6
Ø120	Ø80	Ø100	2,5	M6

Flange B5 / Flanges B5				
F	N	M	T	S
Ø160	Ø110	Ø130	3	Ø9,5
Ø200	Ø130	Ø165	3	Ø11

Tipo / Type	L	Peso / Weight
V745.6 V746.6	248	8 Kg
V745.9 V746.9	281	10 Kg
V745.12 V746.12	311	12 Kg
V745.18 V746.18	371	16 Kg

# Motore N805 IP55 - N806 IP66

## Motor N805 IP55 - N806 IP66

**S2-S3** SERVIZIO INTERMITTENTE  
INTERMITTENT DUTY **0,55-2,2kW**

Motori C.C. a norme CEI ed IEC - magnete permanente - 4 poli  
D.C. motors CEI and IEC standards - permanent magnet - 4 poles

Alimentazione da batteria - tensione nominale 12/24/48V  
Battery supply - rated voltage 12/24/48V

Fattore di forma 1 - isolamento classe F / H - senza ventilazione  
Form factor 1 - insulation F / H class - without ventilation

N805 protezione IP55 - N806 protezione IP66  
N805 protection IP55 - N806 protection IP66

N805 uscita cavi o scatola morsetti - N806 solo uscita cavi senza albero posteriore  
N805 free cables or terminal box - N806 only free cables without back shaft



Tipo Type	Potenza Power	Tensione/Corrente Voltage/Current	Velocità Speed	Coppia Torque	Potenza Power	Tensione/Corrente Voltage/Current	Velocità Speed	Coppia Torque	Potenza Power	Tensione/Corrente Voltage/Current	Velocità Speed	Coppia Torque
N805.19	0,55 kW	12 V - 55 A	1500 rpm	3,5 Nm	0,75 kW	12 V - 75 A	2200 rpm	3,3 Nm	1,1 kW	12 V - 110 A	3000 rpm	3,5 Nm
		24 V - 27 A				24 V - 37 A				24 V - 55 A		
N806.19		48 V - 14 A				48 V - 19 A				48 V - 27 A		
N805.27	0,75 kW	12 V - 75 A	1500 rpm	4,8 Nm	1 kW	12 V - 100 A	2000 rpm	4,8 Nm	1,5 kW	12 V - 110 A	3000 rpm	4,8 Nm
		24 V - 37 A				24 V - 50 A				24 V - 75 A		
N806.27		48 V - 19 A				48 V - 25 A				48 V - 37 A		
N805.38	1,1 kW	12 V - 110 A	1500 rpm	7 Nm	1,5 kW	12 V - 110 A	2200 rpm	6,5 Nm	2,2 kW	12 V - 110 A	3000 rpm	7 Nm
		24 V - 55 A				24 V - 75 A				24 V - 110 A		
N806.38		48 V - 27 A				48 V - 37 A				48 V - 55 A		

Tolleranza / Tolerance ±10%

Max. 1,1 kW a / at 12 V Max. 2,2 kW a / at 24 V

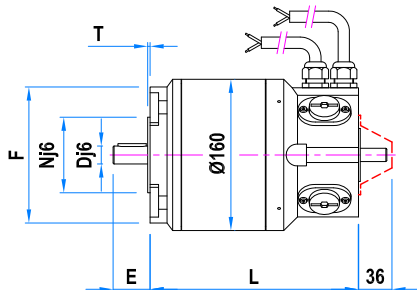

80 B14

90 B14

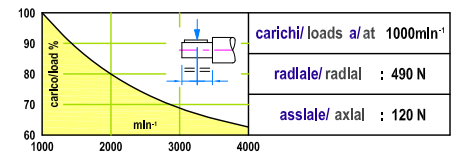
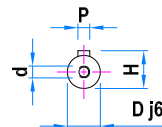
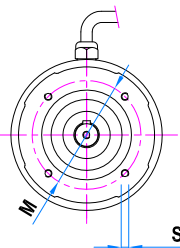

Alberi / Shafts

D	E	P	H	d
Ø19	40	6x6x30	21.5	M6
Ø24	50	8x7x35	27	M8

Flange B5 / Flanges B5

F	N	M	T	S
Ø200	Ø130	Ø165	3	10.5

Flange B14 / Flanges B14

F	N	M	T	S
Ø120	Ø80	Ø100	2.5	M6
Ø140	Ø95	Ø115	3	M8

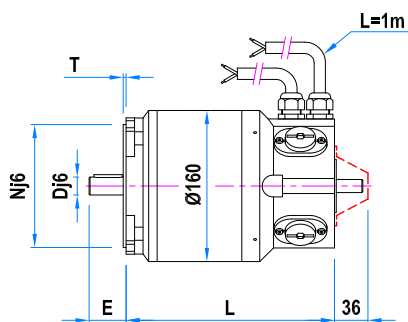

80 B5

90 B5

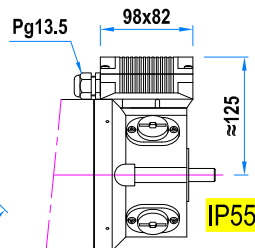
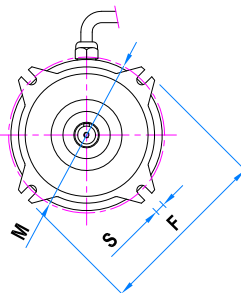

Morsetti / Terminal box

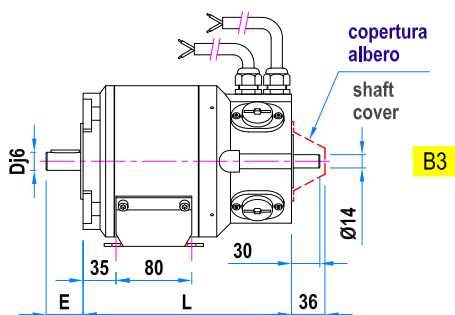

B3

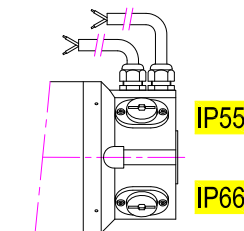
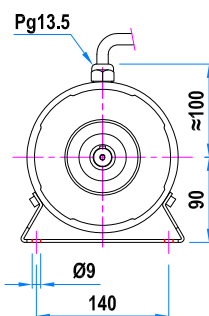

Uscita cavi / Free cables

Tipo / Type	L	Peso / Weight
N805.19 N806.19	222	12 Kg
N805.27 N806.27	252	15 Kg
N805.38 N806.38	277	18.5 Kg



# Motore V805 IP55 - V806 IP66

## Motor V805 IP55 - V806 IP66

**S1** SERVIZIO CONTINUO  
CONTINUOUS DUTY **0,55-2,2kW**

Motori C.C. a norme CEI ed IEC - magnete permanente - 4 poli  
D.C. motors CEI and IEC standards - permanent magnet - 4 poles

Alimentazione da batteria - tensione nominale 12/24/48V  
Battery supply - rated voltage 12/24/48V

Fattore di forma 1 - isolamento classe F / H - autoventilato  
Form factor 1 - insulation F / H class - selfventilated

V805 protezione IP55 - V806 protezione IP66  
V805 protection IP55 - V806 protection IP66

V805 uscita cavi o scatola morsetti - V806 solo uscita cavi  
V805 free cables or terminal box - V806 only free cables



Tipo Type	Potenza Power	Tensione/Corrente Voltage/Current	Velocità Speed	Coppia Torque	Potenza Power	Tensione/Corrente Voltage/Current	Velocità Speed	Coppia Torque	Potenza Power	Tensione/Corrente Voltage/Current	Velocità Speed	Coppia Torque
V805.19	0,55 kW	12 V - 55 A	1500 rpm	3,5 Nm	0,75 kW	12 V - 75 A	2200 rpm	3,3 Nm	1,1 kW	12 V - 110 A	3000 rpm	3,5 Nm
		24 V - 27 A				24 V - 37 A				24 V - 55 A		
V806.19		48 V - 14 A				48 V - 19 A				48 V - 27 A		
V805.27	0,75 kW	12 V - 75 A	1500 rpm	4,8 Nm	1 kW	12 V - 100 A	2000 rpm	4,8 Nm	1,1 kW	12 V - 110 A	3000 rpm	3,5 Nm
		24 V - 37 A				24 V - 50 A				24 V - 75 A		
V806.27		48 V - 19 A				48 V - 25 A				48 V - 37 A		4,8 Nm
V805.38	1,1 kW	12 V - 110 A	1500 rpm	7 Nm	1,5 kW	12 V - 110 A	2200 rpm	4,8 Nm	---	---	3000 rpm	---
		24 V - 55 A				24 V - 75 A				24 V - 110 A		
V806.38		48 V - 27 A				48 V - 37 A		6,5 Nm	2,2 kW	48 V - 55 A		7 Nm

Tolleranza / Tolerance  $\pm 10\%$  Max. 1,1 kW a / at 12 V Max. 2,2 kW a / at 24 V

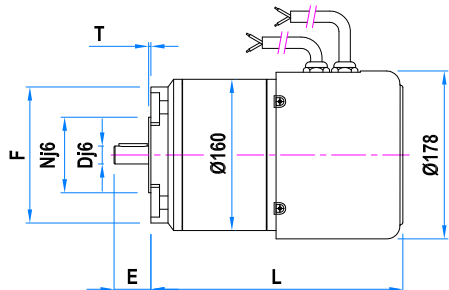

80 B14  
90 B14

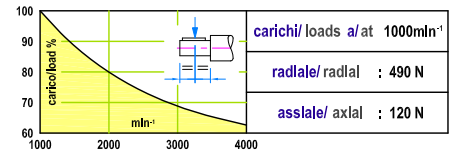
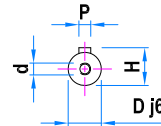
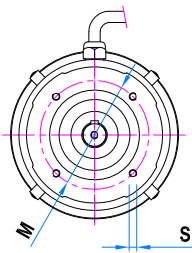

### Alberi / Shafts

D	E	P	H	d
Ø19	40	6x6x30	21,5	M6
Ø24	50	8x7x35	27	M8

### Flange B5 / Flanges B5

F	N	M	T	S
Ø200	Ø130	Ø165	3	10.5

### Flange B14 / Flanges B14

F	N	M	T	S
Ø120	Ø80	Ø100	2.5	M6
Ø140	Ø95	Ø115	3	M8

Tipo / Type	L	Peso / Weight
V805.19 V806.19	267	12.5 Kg
V805.27 V806.27	297	15.5 Kg
V805.38 V806.38	322	19 Kg

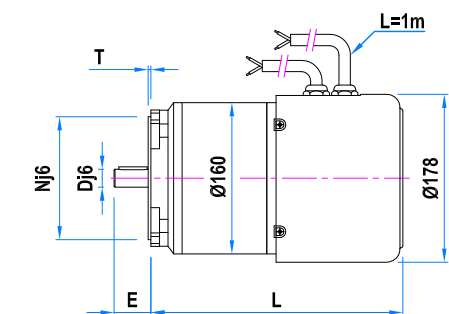

80 B5  
90 B5

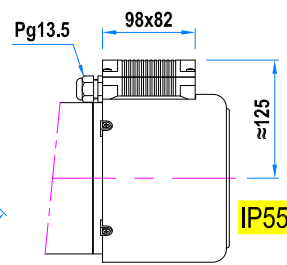
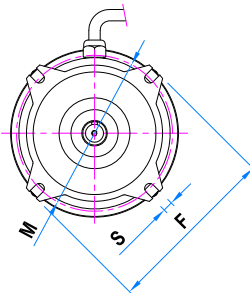

Morsettiera / Terminal box

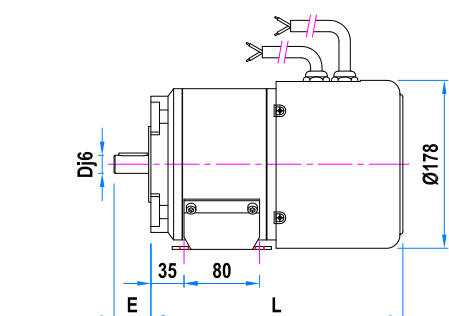

B3

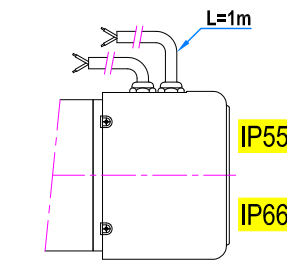
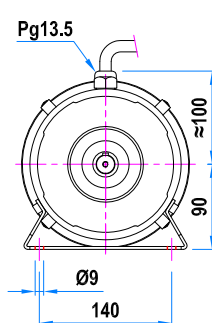

Uscita cavi / Free cables

# Motore N88 IP54

## Motor N88 IP54

**S2-S3** SERVIZIO INTERMITTENTE  
INTERMITTENT DUTY **1,1-4,4kW**

Motori C.C. a norme CEI ed IEC - magnete permanente - 4 poli  
D.C. motors CEI and IEC standards - permanent magnet - 4 poles  
Alimentazione da batteria - tensione nominale 12/24/36/48/72/110V  
Battery supply - rated voltage 12/24/36/48/72/110V

Fattore di forma 1 - senza ventilazione  
Form factor 1 - not ventilated

Protezione IP54 - isolamento classe F / H  
Protection IP54 - insulation F / H class

Scatola morsetti  
Terminal box



Tipo Type	Potenza Power	Tensione/Corrente Voltage/Current	Velocità Speed	Coppia Torque	Potenza Power	Tensione/Corrente Voltage/Current	Velocità Speed	Coppia Torque	Potenza Power	Tensione/Corrente Voltage/Current	Velocità Speed	Coppia Torque
N88.38	1,1 kW	12 V - 110 A	1500 rpm	7 Nm	1,1 kW	12 V - 110 A	2200 rpm	4,8 Nm	--	--	--	--
	1,2 kW	24 V - 60 A		7,6 Nm	2,2 kW	24 V - 110 A		3000 rpm	7 Nm			
		36 V - 40 A		6,5 Nm	3,3 kW	36 V - 74 A		3200 rpm	6,6 Nm			
		48 V - 30 A		10,7 Nm	3,3 kW	48 V - 55 A		3000 rpm	7 Nm			
N88.57	1,1 kW	12 V - 110 A	1500 rpm	7 Nm	--	--	--	--	--	--	--	--
	1,7 kW	24 V - 85 A		10,8 Nm	2,2 kW	24 V - 110 A	1950 rpm	10,7 Nm	2,2 kW	24 V - 110 A	3000 rpm	7 Nm
		36 V - 57 A		2,2 kW	36 V - 74 A	2100 rpm	10 Nm	3,3 kW	36 V - 110 A	10,5 Nm		
		48 V - 42 A		10,7 Nm	3,3 kW	48 V - 83 A	1950 rpm	10,7 Nm				
N88.81	1,1 kW	12 V - 110 A	1100 rpm	9,6 Nm	--	--	--	--	--	--	--	--
	2,2 kW	24 V - 110 A	1500 rpm	14 Nm	2,2 kW	24 V - 110 A	2200 rpm	9,6 Nm	--	--	--	--
		36 V - 74 A		3,3 kW	36 V - 100 A	13 Nm		3,3 kW	36 V - 110 A	3400 rpm	9,3 Nm	
		48 V - 55 A		4,4 kW	48 V - 75 A	13 Nm		4,4 kW	48 V - 110 A	3000 rpm	14 Nm	

Tolleranza / Tolerance ±10%      Max. 1,1 kW a / at 12 V      Max. 2,2 kW a / at 24 V      Max. 3,3 kW a / at 36 V      Max. 4,4 kW a / at 48 V

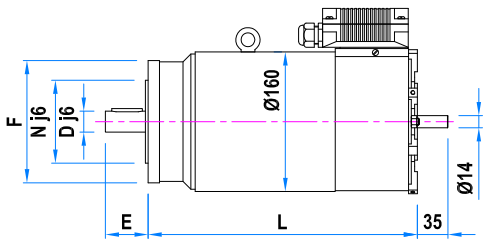

B 14

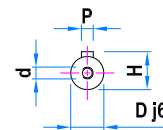
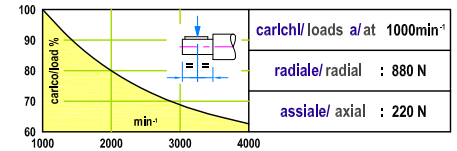
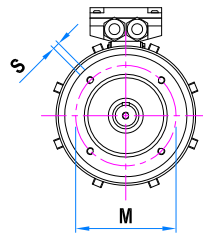

**Alberi / Shafts**

D	E	P	H	d
Ø19	40	6x6x30	21,5	M6
Ø24	50	8x7x35	27	M8

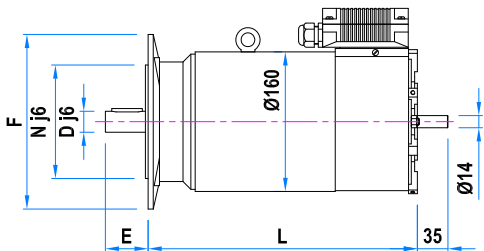

B 5

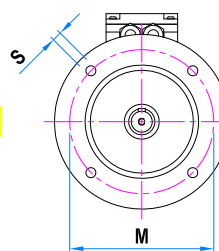

**Flange B5 / Flanges B5**

F	N	M	T	S
Ø200	Ø130	Ø165	3	Ø11

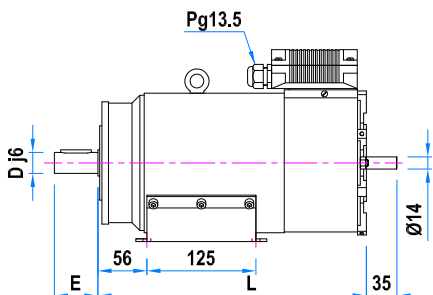

B 3

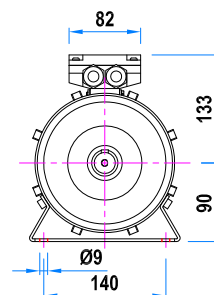

**Flange B14 / Flanges B14**

F	N	M	T	S
Ø140	Ø95	Ø115	3	M8

Tipo / Type	L	Peso / Weight
N88.38	309	22 Kg
N88.57	364	29,6 Kg
N88.81	419	37,2 Kg

# Motore V88 IP54

## Motor V88 IP54

**S1** SERVIZIO CONTINUO  
CONTINUOUS DUTY **1,1-4,4kW**

Motori C.C. a norme CEI ed IEC - magnete permanente - 4 poli  
D.C. motors CEI and IEC standards - permanent magnet - 4 poles  
Alimentazione da batteria - tensione nominale 12/24/36/48/72/110V  
Battery supply - rated voltage 12/24/36/48/72/110V

Fattore di forma 1 - autoventilato  
Form factor 1 - selfventilated

Protezione IP54 - isolamento classe F / H  
Protection IP54 - insulation F / H class

Scatola morsetti  
Terminal box



Tipo Type	Potenza Power	Tensione/Corrente Voltage/Current	Velocità Speed	Coppia Torque	Potenza Power	Tensione/Corrente Voltage/Current	Velocità Speed	Coppia Torque	Potenza Power	Tensione/Corrente Voltage/Current	Velocità Speed	Coppia Torque
V88.38	1,1 kW	12 V - 110 A	1500 rpm	7 Nm	1,1 kW	12 V - 110 A	2200 rpm	4,8 Nm	--	--	--	--
	1,2 kW	24 V - 60 A		7,6 Nm	1,5 kW	24 V - 75 A		6,5 Nm	2,2 kW	24 V - 110 A	3000 rpm	7 Nm
		36 V - 40 A				36 V - 50 A			3200 rpm	6,6 Nm		
		48 V - 30 A				48 V - 37 A			3000 rpm	7 Nm		
V88.57	1,1 kW	12 V - 110 A	1500 rpm	7 Nm	--	--	--	--	--	--	--	--
	1,7 kW	24 V - 85 A		10,8 Nm	2,2 kW	24 V - 110 A	1950 rpm	10,7 Nm	2,2 kW	24 V - 110 A	3000 rpm	7 Nm
		36 V - 57 A				36 V - 74 A	2100 rpm	10 Nm	3,3 kW	36 V - 110 A		10,5 Nm
		48 V - 42 A				48 V - 55 A	1950 rpm	10,7 Nm	3,3 kW	48 V - 83 A		10,5 Nm
V88.81	1,1 kW	12 V - 110 A	1100 rpm	9,6 Nm	--	--	--	--	--	--	--	--
	2,2 kW	24 V - 110 A	1500 rpm	14 Nm	2,2 kW	2200 rpm	9,6 Nm	13 Nm	--	--	--	--
		36 V - 74 A							24 V - 110 A	3400 rpm	9,3 Nm	
		48 V - 55 A							36 V - 100 A	3000 rpm	14 Nm	
					3 kW	48 V - 75 A						

Tolleranza / Tolerance ±10% Max. 1,1 kW a / at 12 V Max. 2,2 kW a / at 24 V Max. 3,3 kW a / at 36 V Max. 4,4 kW a / at 48 V

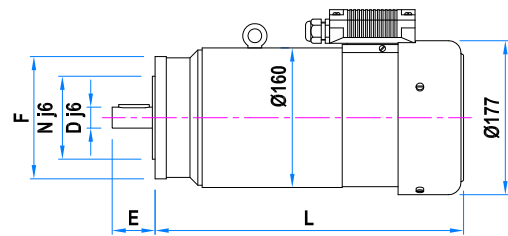

B 14

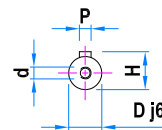
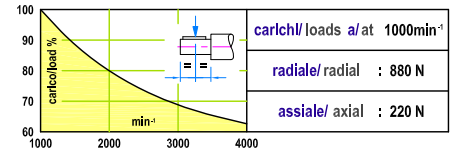
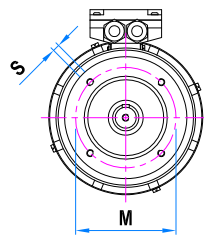

### Alberi / Shafts

D	E	P	H	d
Ø19	40	6x6x30	21,5	M6
Ø24	50	8x7x35	27	M8

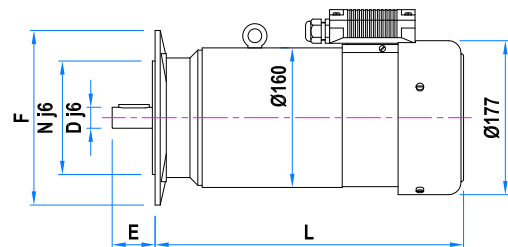

B 5

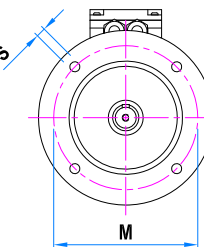

### Flange B5 / Flanges B5

F	N	M	T	S
Ø200	Ø130	Ø165	3	Ø11

### Flange B14 / Flanges B14

F	N	M	T	S
Ø140	Ø95	Ø115	3	M8

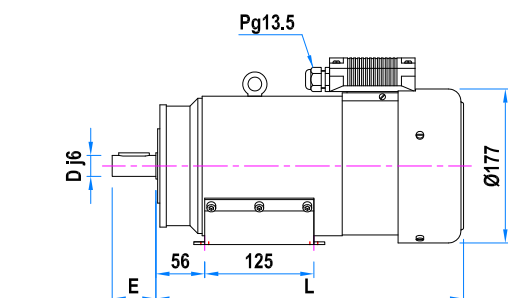

B 3

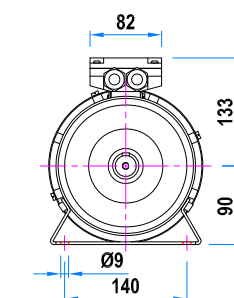

Tipo / Type	L	Peso / Weight
V88.38	354	22 Kg
V88.57	409	29,6 Kg
V88.81	464	37,2 Kg

# Motore ME80 - 100 - 112 - 132 IP23

# Motor ME80 - 100 - 112 - 132 IP23

**S1** SERVIZIO CONTINUO  
CONTINUOUS DUTY

**0.38-14kW**

Motori C.C. a norme CEI ed IEC - eccitazione separata con poli ausiliari  
D.C. motors CEI and IEC standards - shunt field with interpoles

Alimentazione da batteria - tensione armatura 12/24/36/48/72/110V  
Battery supply - armature voltage 12/24/36/48/72/110V

Autoventilato IC01 protezione IP23 - autoventilato IC411 protezione IP54 o IP55  
Selfventilated IC01 protection IP23 - selfventilated IC411 protection IP54 or IP55

Scatola morsetti o fili uscenti  
Terminal box or free wires

Protezione IP54 o IP55 a richiesta  
IP54 or IP55 protection on request



Tipo / Type	ØAC	LB	Peso / Weight	Potenza a / Power at			
				1400 / 1600 rpm	1800 / 2200 rpm	2300 / 2700 rpm	2800 / 3200 rpm
ME80R	157	285	17 kg	0.38 kW	0.5 kW	0.65 kW	0.75 kW
ME80S	157	305	19 kg	0.5 kW	0.7 kW	0.8 kW	1 kW
ME100R	192	310	26 kg	0.65 kW	0.8 kW	1 kW	1.3 kW
ME100S	192	330	31 kg	0.9 kW	1.2 kW	1.5 kW	1.7 kW
ME100T	192	330	33 kg	1.1 kW	1.4 kW	2 kW	2.6 kW
ME112R	220	335	36 kg	1.7 kW	2.2 kW	2.5 kW	3.2 kW
ME112S	220	335	40 kg	2.3 kW	2.7 kW	3.2 kW	4 kW
ME112T	220	375	45 kg	2.5 kW	3.3 kW	4 kW	4.7 kW
ME112L	220	405	51 kg	2.8 kW	3.8 kW	4.5 kW	5.5 kW
ME132R	260	390	66 kg	3.7 kW	5.2 kW	6.2 kW	8 kW
ME132S	260	415	76 kg	4.8 kW	6.4 kW	7 kW	9 kW
ME132T	260	440	86 kg	6 kW	8 kW	9 kW	10 kW
ME132L	260	480	110 kg	8 kW	10 kW	12 kW	14 kW

DATI INDICATIVI. Richiedere dimensionamento in fase di scelta del prodotto/ PROVISIONAL DATA. Contact us for the updates

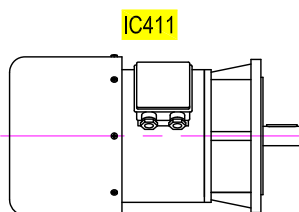
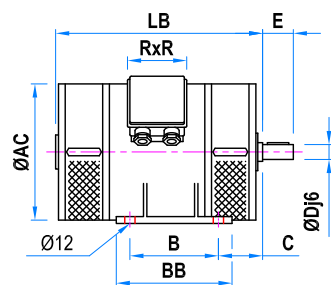
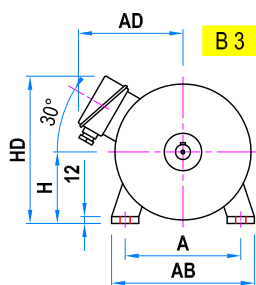

Tipo Type	Alberi / Shafts				
	D	E	P	H	d
ME80	Ø14	30	5x5x20	16	M5
ME80-100	Ø19	40	6x6x25	21.5	M6
ME100-112	Ø24	50	8x7x35	27	M8
ME112-132	Ø28	60	8x7x40	31	M10
ME132	Ø38	80	10x8x60	41	M12

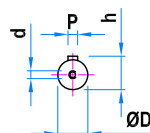
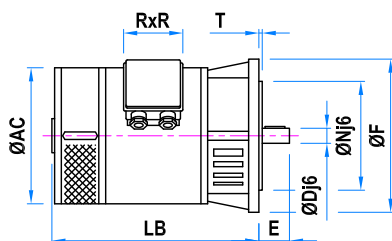
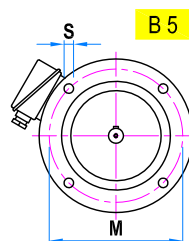

Tipo Type	Flange B5 / Flanges B5				
	F	N	M	T	S
ME80	Ø160	Ø110	Ø130	3.5	Ø9.5
ME80-100	Ø200	Ø130	Ø165	3.5	Ø11.5
ME112	Ø250	Ø180	Ø215	4	Ø14
ME132	Ø300	Ø230	Ø265	4	Ø14

Tipo / Type	H	C	B	A	AB	BB	HD	AD	RxR
ME80	80	50	100	125	158	138	177	155	100
ME100	100	63	140	160	200	190	205	165	100
ME112	112	70	140	190	235	190	218	180	100
ME132	132	89	178	216	256	215	280	225	125

Tipo Type	Flange ridotte / Short flanges				
	F	N	M	T	S
ME100	Ø192	Ø110	Ø130	3.5	M8
ME112	Ø220	Ø130	Ø165	3.5	Ø11.5
ME132	Ø260	Ø180	Ø215	4	Ø14

# Assemblaggio accessori per motori c.c. alimentazione da batteria

## Accessories assembly for d.c. motors battery supply

Motore M35  
Motor M35

Tipo / Type	L
M35.3	99.5
M35.4	112
M35.6	132
M35.9	163

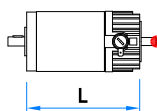

FRE0.5A1024  
EH30FL62

Motore N505  
Motor N505

Tipo / Type	L
N505.5	153.5
N505.10	200.5

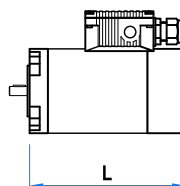

FRE2.5A1024  
EH30FL62

Motore LN56  
Motor LN56

Tipo / Type	L
LN56.5	149
LN56.10	196
LN56.15	241

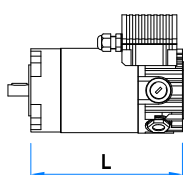

FRE2.5A1024  
EH30FL62

Motore LV56  
Motor LV56

Tipo / Type	LA
LV56.5	219
LV56.10	266
LV56.15	311

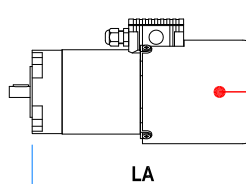

FRLAV2A10

Motore LN70 - IP54  
Motor LN70 - IP54

Tipo / Type	L
LN70.5	156.5
LN70.10	206.5
LN70.15	256.5

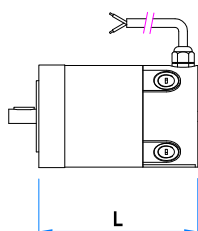

FRE2.5A1024  
FRE4A1024  
FRE45A1024  
EH30FL62

Motore LN70 - IP66  
Motor LN70 - IP66

Tipo / Type	LF
LN70.5	187
LN70.10	237
LN70.15	287

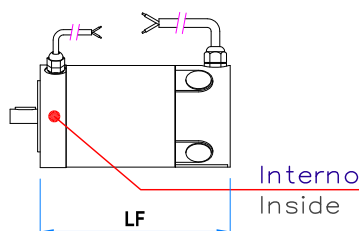

FRI2.5A17

Interno  
Inside

Motore M71\_  
Motor M71\_

Tipo / Type	L
M71_3	156
M71_5	171
M71_7	186
M71_9	218
M71_13	249

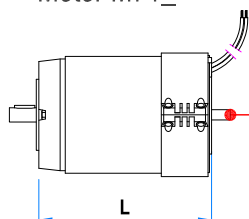

FRE1.5A1024  
FRE2.5A1024  
FRE4A1024  
FRE45A1024  
EH30

Motore MV71\_  
Motor MV71\_

Tipo / Type	L
MV71_3	156
MV71_5	171
MV71_7	186
MV71_9	218
MV71_13	249

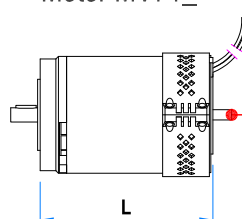

FRE1.5A1024  
FRE2.5A1024  
FRE4A1024  
FRE45A1024  
EH30

Motore N745  
Motor N745

Tipo / Type	L
N745.6	214
N745.9	247
N745.12	277
N745.18	337

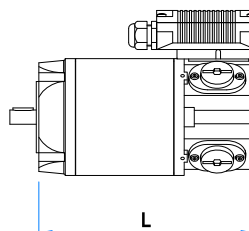

FRE4A1424  
FRE45A1424  
FRE7A1424  
FRE8A1424  
Encoder a richiesta  
Encoder on demand

Motore V745  
Motor V745

Tipo / Type	LA
V745.6	303
V745.9	336
V745.12	366
V745.18	426

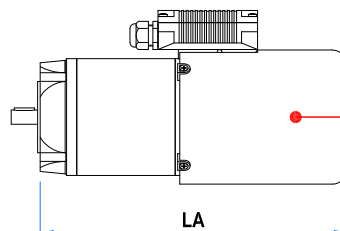

FRE4A1424  
FRE45A1424  
FRE7A1424  
FRE8A1424

# Assemblaggio accessori per motori c.c. alimentazione da batteria

## Accessories assembly for d.c. motors battery supply

Motore N805  
Motor N805

Tipo / Type	L
N805.19	222
N805.27	252
N805.38	277

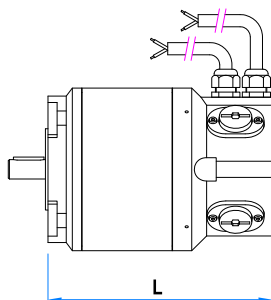

FRE7A1424  
FRE8A1424

Motore N88  
Motor N88

Tipo / Type	L
N88.38	309
N88.57	364
N88.81	419

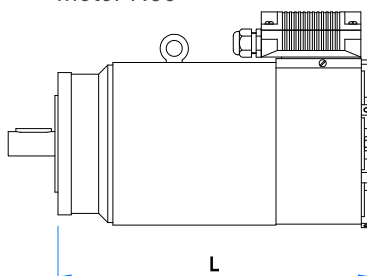

FRE15A1424  
FRE16A1424  
Encoder a richiesta  
Encoder on demand

Motore V88  
Motor V88

Tipo / Type	LA
V88.38	414
V88.57	469
V88.81	524

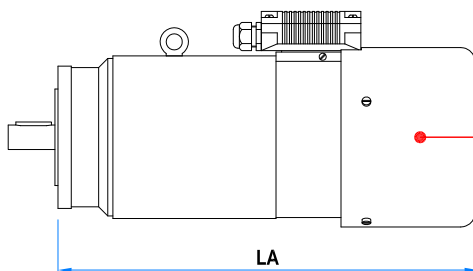

FRE15A1424  
FRE16A1424

Tipo / Type	LB
ME80R	285
ME80S	305
ME100R	310
ME100S / T	330
ME112R / S	335
ME112T	375
ME112L	405
ME132R	390
ME132S	415
ME132T	440
ME132L	480

Motore ME  
Motor ME

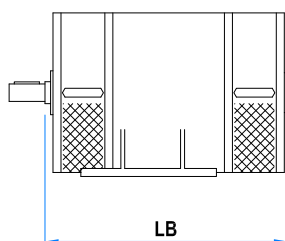

FRE4  
FRE45  
FRE7  
FRE8  
FRE15  
FRE16  
FRE31  
FRE32  
FRE59  
FRE60

# Caratteristiche accessori per motori c.c. alimentazione da batteria

## Accessories features for d.c. motors battery supply

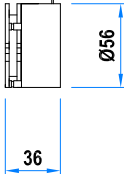
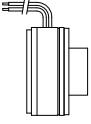
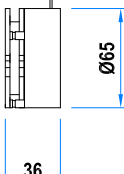
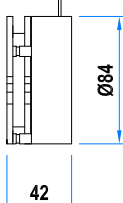
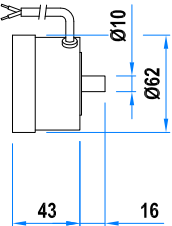
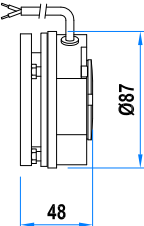
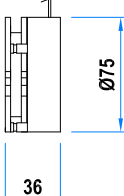
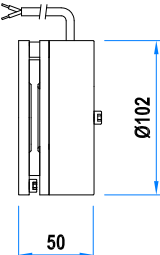
<p><b>FRE0.5A1024</b> Freno esterno External brake</p> <p>A mancanza di alimentazione With lack of supply</p> <p>Coppia 0.5Nm Torque 0.5Nm</p> <p>Alimentazione 24Vcc - 9W Supply 24Vdc - 9W</p> <p>Peso 0.4 kg Weight 0.4 kg</p> <p>Fili uscenti Free wires</p> 	<p><b>FRI2.5A17</b> Freno interno Internal brake</p> <p>A mancanza di alimentazione With lack of supply</p> <p>Coppia 2.5Nm Torque 2.5Nm</p> <p>Alimentazione 24Vcc - 13.5W Supply 24Vdc - 13.5W</p> <p>Peso 0.9 kg Weight 0.9 kg</p> <p>Fili uscenti Free wires</p> 
<p><b>FRE1.5A1024</b> Freno esterno External brake</p> <p>A mancanza di alimentazione With lack of supply</p> <p>Coppia 1.5Nm Torque 1.5Nm</p> <p>Alimentazione 24Vcc - 12.5W Supply 24Vdc - 12.5W</p> <p>Peso 0.5 kg Weight 0.5 kg</p> <p>Fili uscenti Free wires</p> 	<p><b>FRE4A1024</b> Freno esterno External brake</p> <p>A mancanza di alimentazione With lack of supply</p> <p>Coppia 4Nm Torque 4Nm</p> <p>Alimentazione 24Vcc - 20W Supply 24Vdc - 20W</p> <p>Peso 1.2Kg Weight 1.2Kg</p> <p>Morsettiere motore o fili uscenti Motor terminal box or free wires</p> 
<p><b>FRLAV2A10</b> Freno esterno External brake</p> <p>A mancanza di alimentazione With lack of supply</p> <p>Coppia 1.7Nm Torque 1.7Nm</p> <p>Alimentazione 24Vcc - 12W Supply 24Vdc - 12W</p> <p>Peso 0.8 kg Weight 0.8 kg</p> <p>Morsettiere motore Motor terminal box</p> 	<p><b>FRE45A1424</b> Freno esterno External brake</p> <p>A mancanza di alimentazione With lack of supply</p> <p>Coppia 4Nm Torque 4Nm</p> <p>Alimentazione 12/48Vcc - 20W Supply 12/48Vdc - 20W</p> <p>Altre tensioni a richiesta Some more voltages on demand</p> <p>Peso 1.2 kg Weight 1.2 kg</p> <p>Morsettiere motore o fili uscenti Motor terminal box or free wires</p> 
<p><b>FRE2.5A1024</b> Freno esterno External brake</p> <p>A mancanza di alimentazione With lack of supply</p> <p>Coppia 2Nm Torque 2Nm</p> <p>Alimentazione 24Vcc - 13W Supply 24Vdc - 13W</p> <p>Peso 1.1 kg Weight 1.1 kg</p> <p>Morsettiere motore o fili uscenti Motor terminal box or free wires</p> 	<p><b>FRE7A1424</b> Freno esterno External brake</p> <p>A mancanza di alimentazione With lack of supply</p> <p>Coppia 8Nm Torque 8Nm</p> <p>Alimentazione 24Vcc - 25W Supply 24Vdc - 25W</p> <p>Peso 2.3 kg Weight 2.3 kg</p> <p>Morsettiere motore o fili uscenti Motor terminal box or free wires</p> 

# Caratteristiche accessori per motori c.c. alimentazione da batteria

## Accessories features for d.c. motors battery supply

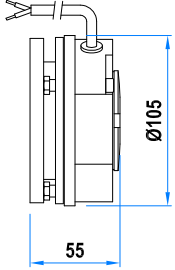
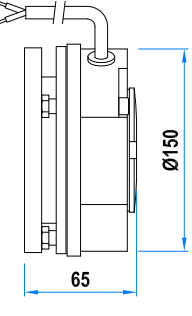
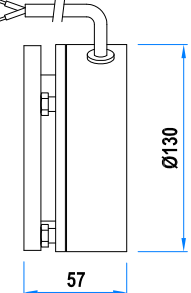
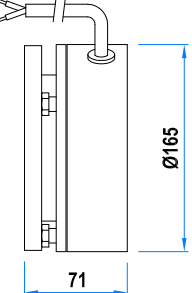
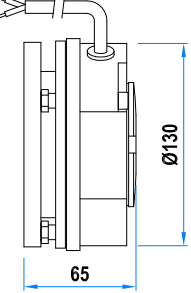
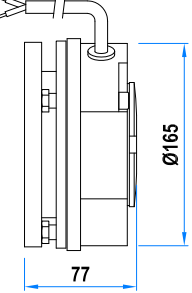
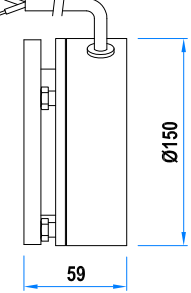
<p><b>FRE8A1424</b> Freno esterno External brake</p> <p>A mancanza di alimentazione With lack of supply</p> <p>Coppia 8Nm Torque 8Nm</p> <p>Alimentazione 12/48Vcc - 25W Supply 12/48Vdc - 25W</p> <p>Altre tensioni a richiesta Some more voltages on demand</p> <p>Peso 2 kg Weight 2 kg</p> <p>Morsettiera motore o fili uscenti Motor terminal box or free wires</p> 	<p><b>FRE32A1424</b> Freno esterno External brake</p> <p>A mancanza di alimentazione With lack of supply</p> <p>Coppia 32Nm Torque 32Nm</p> <p>Alimentazione 12/48Vcc - 40W Supply 12/48Vdc - 40W</p> <p>Peso 4.5Kg Weight 4.5Kg</p> <p>Fili uscenti Free wires</p> 
<p><b>FRE15A1424</b> Freno esterno External brake</p> <p>A mancanza di alimentazione With lack of supply</p> <p>Coppia 16Nm Torque 16Nm</p> <p>Alimentazione 24Vcc - 30W Supply 24Vdc - 30W</p> <p>Peso 3.1Kg Weight 3.1Kg</p> <p>Morsettiera motore o fili uscenti Motor terminal box or free wires</p> 	<p><b>FRE59A1424</b> Freno esterno External brake</p> <p>A mancanza di alimentazione With lack of supply</p> <p>Coppia 60Nm Torque 60Nm</p> <p>Alimentazione 24Vcc - 50W Supply 24Vdc - 50W</p> <p>Peso 6.2Kg Weight 6.2Kg</p> <p>Fili uscenti Free wires</p> 
<p><b>FRE16A1424</b> Freno esterno External brake</p> <p>A mancanza di alimentazione With lack of supply</p> <p>Coppia 16Nm Torque 16Nm</p> <p>Alimentazione 12/48Vcc - 30W Supply 12/48Vdc - 30W</p> <p>Peso 3.1Kg Weight 3.1Kg</p> <p>Morsettiera motore o fili uscenti Motor terminal box or free wires</p> 	<p><b>FRE60A1424</b> Freno esterno External brake</p> <p>A mancanza di alimentazione With lack of supply</p> <p>Coppia 60Nm Torque 60Nm</p> <p>Alimentazione 12/48Vcc - 50W Supply 12/48Vdc - 50W</p> <p>Peso 6.2Kg Weight 6.2Kg</p> <p>Fili uscenti Free wires</p> 
<p><b>FRE31A1424</b> Freno esterno External brake</p> <p>A mancanza di alimentazione With lack of supply</p> <p>Coppia 32Nm Torque 32Nm</p> <p>Alimentazione 24Vcc - 40W Supply 24Vdc - 40W</p> <p>Peso 4.5Kg Weight 4.5Kg</p> <p>Fili uscenti Free wires</p> 	<p><b>LSBL_</b> Leva di sblocco manuale Manual release</p> <p>Leva di sblocco manuale a richiesta Manual release on demand</p> <p>Non disponibile per: Not available for: FRE0.5/FRE1.5/FRLAV2</p> 